

ENCORE 28, 33, 38

Model:

L28

L33

L38

S28

S33

S38

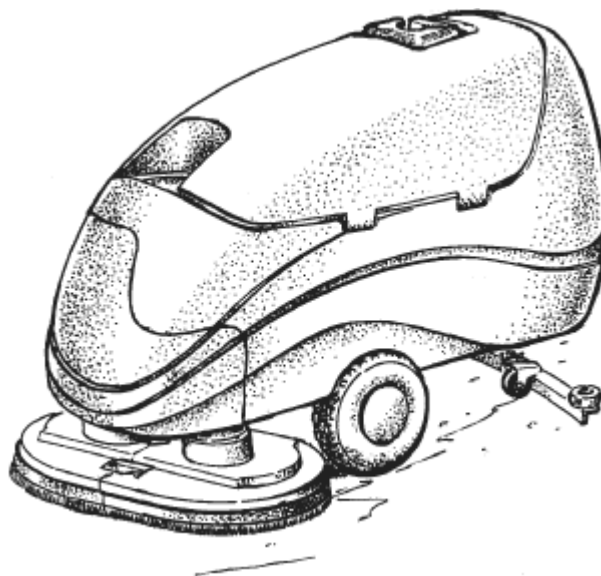

Part List English

16-10-2014

Table of Contents

ENCORE 28, 33, 38

Squeegee swing arm	3
Traverse system	6
Brush head	8
Solution recovery system	12
Brush motor	15
Gear box #54238A	17
Vac motor #45019A	19
Transaxle parts	21
Control housing	23
Rear cover	26
Control housing (machines with a 40089A traverse	29
Rear cover (machines with a 40089A traverse contro	32

Squeegee swing arm

ENCORE 28, 33, 38

16-10-2014

Part List ID
ENCORE2802

3

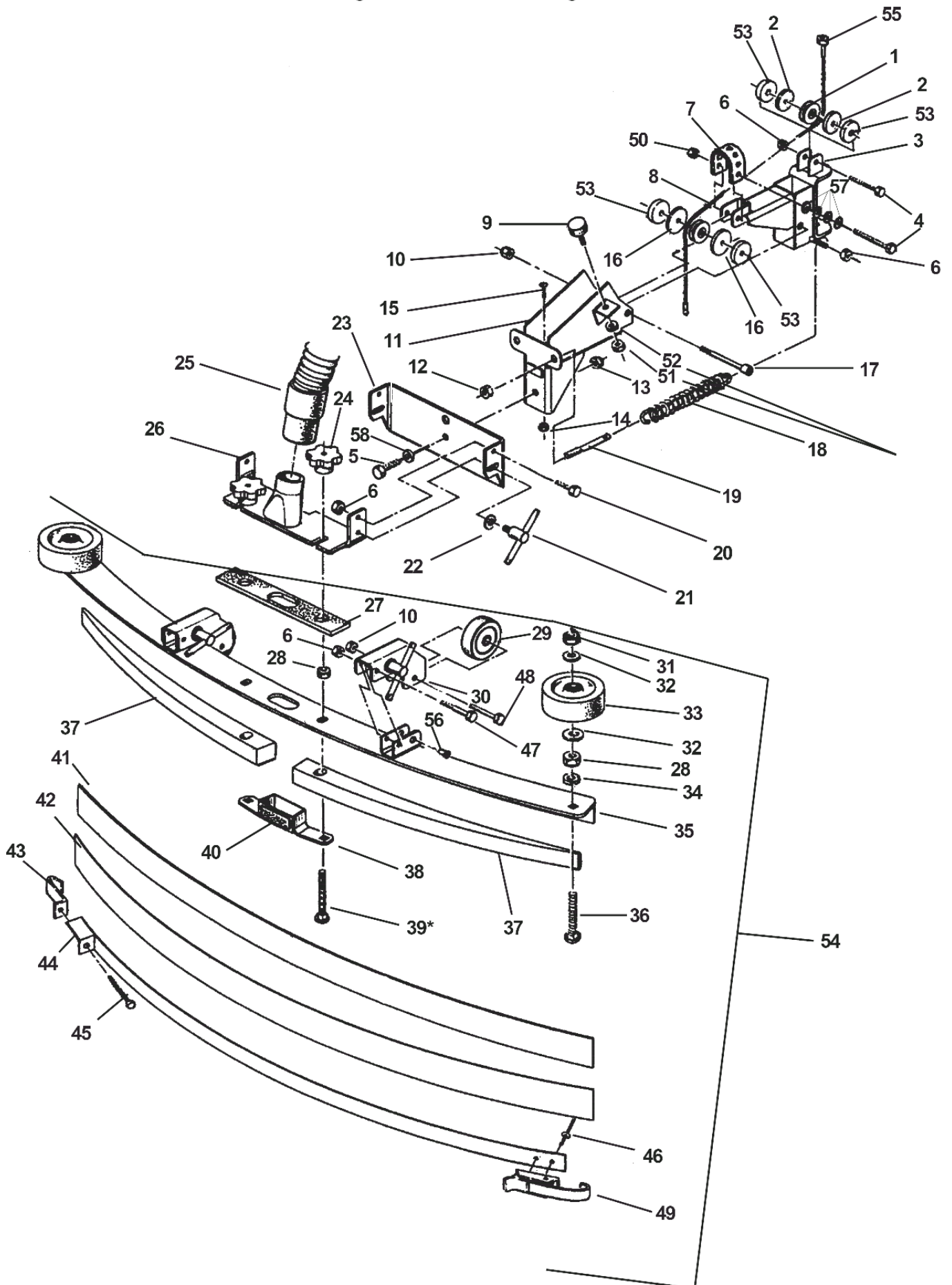

Squeegee swing arm

ENCORE 28, 33, 38

16-10-2014

Part List ID
ENCORE2802

4

Pos	Part no.	Qty	Description	
1	57275A	2	PULLEY	
2	87623A	2	WASHER FLT 1.25 X .26 X . 13N	
3	60452A	1	ARM WELDMENT FRONT (ENCOR E 33)	
4	86004A	2	SCREW 1/4 CLAMP SQ.	
5	85730A	1	SCREW 3/8 16X1&1/4 HEX HD SS	
6	81104A	6	NUT. 1/4-20. ESNA TYPE SS	
7	38021A	1	STRAP HOSE 3.38in (ENCORE	
8	61679A	1	CABLE ASM.ENC.33	
9	51613A	1	BUMPER SQUEG (ENCORE 28/3 8)	
10	920110	3	NUT.LK 5/16-18 REG(PLTD)	
11	60332A	1	REAR ARM WELDMENT (ENCORE 33)	
12	920256	2	NUT-5/16-18 HEX	
13	81105A	1	NUT. 3/8-16. ESNA TYPE SS	
14	920296	1	10-24 ELASTIC STOP NUT	
15	962798	1	SCR 10-24X 1/2 PN*SS	
16	87624A	2	WASHER FLT 1.50X.26X.13N	
17	80015A	1	BOLT. SHOULDER. 3/8 X 2	
18	53423A	2	PRESSURE SQUEEGEE SPRING (ENC)	
19	68016A	2	STUD SQUEEGEE ENCORE	
20	170915	2	SCREW.1/4-20 X 3/4 HX HD(SS)	
21	64905A	3	HANDLE ASM. T (ENCORE)	
22	980651	1	WASHER. 5/16 SAE FLAT	
23	60678C	1	PIVOT BRACKET (LARGE ENCO RE)	
24	25201B	2	KNOB SQUEEGEE T	
25	35192A	1	HOSE RECOVERY EXT 2100	
26	61267A	1	BRACKET WELDMENT TUBE	
27	34260B	1	GASKET. SQUEEGEE (VISION	
28	81301A	4	NUT. 3/8-16. JAM. SS	
29	59971A	2	WHEEL.SQUEEGEE (ENCORE 28 -38)	
30	65975A	2	BRACKET WHEEL SQ	
31	920248	2	NUT 3/8-16 ESNA LIGHT	
32	980645	4	WASHER. 3/8 FLAT SAE	
33	59950A	2	WHEEL. GUIDE (26/32 VISIO	
34	980638	2	LOCKWASHER 3/8 LT SPRING	
35	69636A	1	SQUEEGEE WLD. ENCORE 29IN ACC.	28
35	69673A	1	TOOL	28
35	69674A	1	TOOL	33
35	69675A	1	SQUEEGEE WLDMT (ENCORE 38)	38
36	85610A	2	SCREW. .375-16 X 2.50 PN PH SS	
37	38710A	2	SPACER. SQUEEGEE (VISION	28
37	38711A	2	SPACER. SQUEEGEE. 40in	33
37	38713A	2	SPACER. SQUEEGEE (VISION	28
37	38715A	2	SPACER-SQUEEGEE	38

Squeegee swing arm

ENCORE 28, 33, 38

16-10-2014

Part List ID
ENCORE2802

5

Pos	Part no.	Qty	Description	
38	62712A	1	DUCT. SQUEEGEE INLET (VIS	
39	80011A	2	SCR 3/8 -16X3 CR SS	
40	37016A	1	PAD. SQUEEGEE GRIP AUTOSC	
41	30914A	1	BLADE INNER RUBBER 28"	28
41	30915A	1	BLADE INNER RUBBER 33"	33
41	30930A	1	BLADE INNER RUBBER 28"	28
41	30934A	1	BLADE INNER RUBBER 38"	38
42	30912A	1	BLDE OUTER GUM RUBBER 28"	28
42	30913A	1	BLDE OUTER GUM RUBBER 33"	33
42	30931A	1	BLADE OUTER.GUM RUBBER (V	28
42	30935A	1	BLDE OUTER GUM RUBBER 38"	38
43	62421A	1	CLAMP.END. SQUEEGEE (VISI	
44	62441A	1	CLAMP,WLDMNT,SQG	28
44	62442A	1	CLAMP BANKD SO 28	28
44	62443A	1	SQUEEGEE CLAMP WELDMENT E NC 33	33
44	62444A	1	SQUEEGEE WELDMENT CLAMP E NC 38	38
45	86004A	1	SCREW 1/4 CLAMP SQ.	
46	170932	2	RIVET SQ.CLAMP	
47	85702A	2	SCR 1/4 -20X1&3/4 HX ST	
48	85816A	2	SCREW.5/16-18 X 1 3/4 HX HD	
49	55722A	1	SQ STRAP LATCH (ENC 28/38)	
50	81217A	1	NUT. 1/4-20 X .218H NYLOC	
51	920208	1	NUT.HEX 1/4-20(PLTD)	
52	980657	1	WASHER.LK 1/4 STD	
53	87625A	4	WASHER FLT 1.25X.26X.03N	
54	18815K	1	SQUEEGEE ASSM 28"	28
54	18817N	1	SQUEEGEE ASSEMBLY	38
54	18818A	1	SQUEEGEE ASSM 28"	28
54	56109399	1	SQUEEGEE ASSY	33
55	81303A	1	NUT END SQUARE CABLE	
56	54766A	2	THREADED INSERT (ENC)	
57	87026A	4	WASHER. .250. FLAT. SS	
58	87031A	1	FLAT WASHER 3/8 SS	

Traverse system

ENCORE 28, 33, 38

16-10-2014

Part List ID
ENCORE2804

6

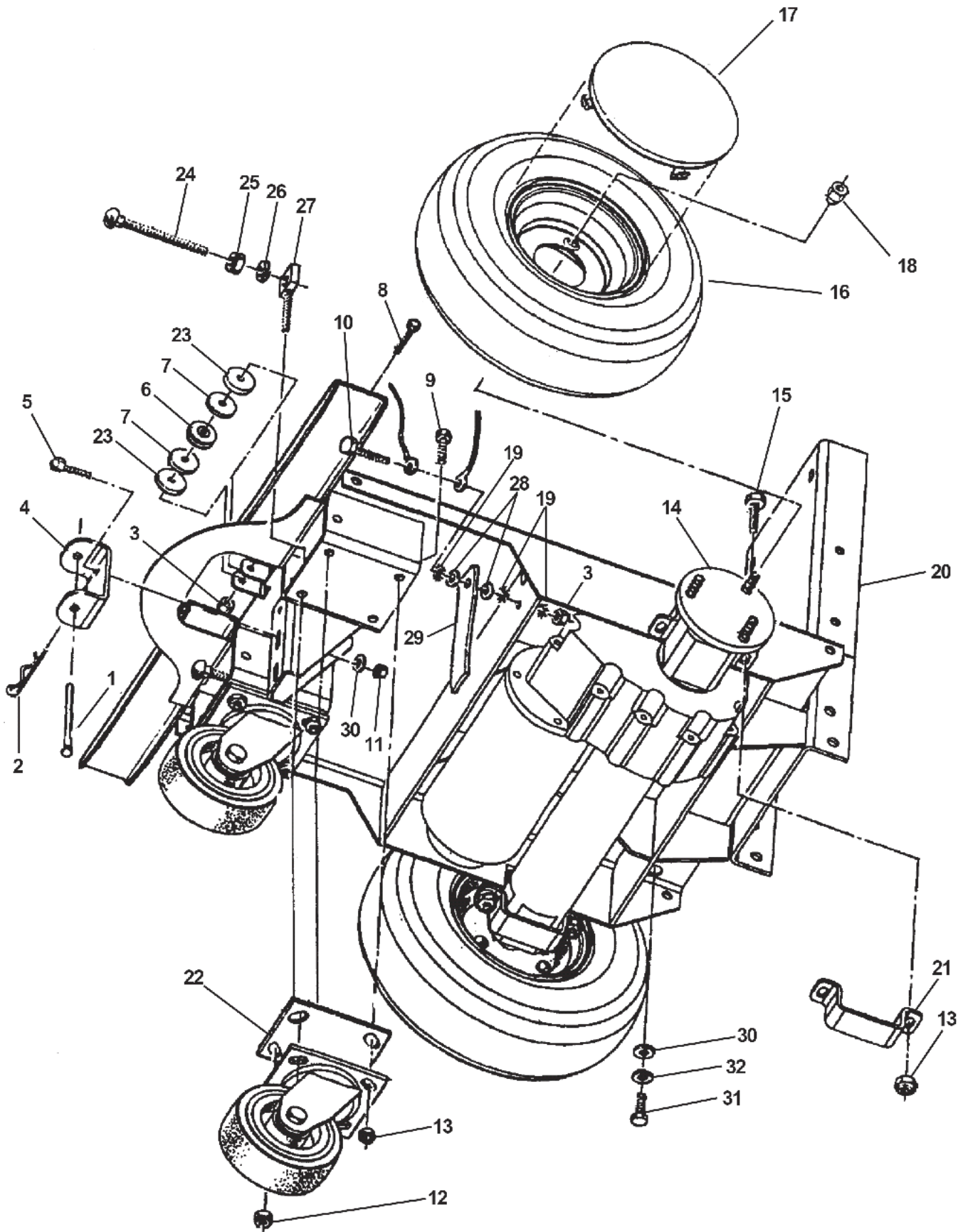

Traverse system

ENCORE 28, 33, 38

16-10-2014

Part List ID
ENCORE2804

7

Pos	Part no.	Qty	Description
1	66531A	1	PIN.SWING ARM. 32 DLX
2	836711	1	HAIRPIN (FOR 8.0MM CLEVIS
3	81104A	2	NUT. 1/4-20. ESNA TYPE SS
4	69877A	1	BRACKET SQ SWING
5	85811A	2	SCREW.5/16-18 X 3/4 HX HD
6	57275A	1	PULLEY
7	87623A	2	WASHER FLT 1.25 X .26 X . 13N
8	86004A	1	SCREW 1/4 CLAMP SQ.
9	85703A	6	SCR 3/8 -16X1&1/2 HX ST CAP
10	85700A	1	SCR 1/4 -20X1 HX ST CAP
11	920110	2	NUT.LK 5/16-18 REG(PLTD)
12	899769	2	CASTER ASM. (TB24/32A. SE
13	81105A	12	NUT. 3/8-16. ESNA TYPE SS
14	10684B	1	BRAKE KIT FOR 59116A note, this is only a brake kit, not a transaxle
14	59116A	1	TRANSAXLE IMPERIAL BLACK
15	85730A	4	SCREW 3/8 16X1&1/4 HEX HD SS
16	59955A	2	WHEEL ASM.. NON-MARKING W /FOAM
16	59969A	2	WHEEL ASM.NON-MARKING WIT HSEAL *30039A TUBE, INNER (INCLUDED IN ITEM #16) 1 REF.
17	32417B	2	COVER.WHEEL BLUE(ENCORE 2 8-32)
18	81221A	6	LUG NUT - WHEEL
19	980614	3	WASHER LK 1/4 EXT TOOTHPLTD
20	60230A	1	MAIN FRAM WELDMENT (ENC)
21	65963A	2	MOUNT TRANSAX
22	69712A	2	PAINTED CASTER SPACER (EN C 33)
23	87625A	2	WASHER FLT 1.25X.26X.03N
24	80011A	2	SCR 3/8 -16X3 CR SS
25	81207A	2	NUT. HEX 3/8-16 SS
26	170883	2	WASHER,LK 3/8 REG(PLTD)
27	58419A	2	STUD
28	980205	2	WASHER
29	69639A	1	STATIC STRAP FUSION
30	980645	6	WASHER. 3/8 FLAT SAE
31	962244	4	SCREW 3/8-16 X 3/4 HX HAD
32	980638	4	LOCKWASHER 3/8 LT SPRING

Brush head

ENCORE 28, 33, 38

16-10-2014

Part List ID
ENCORE2806

8

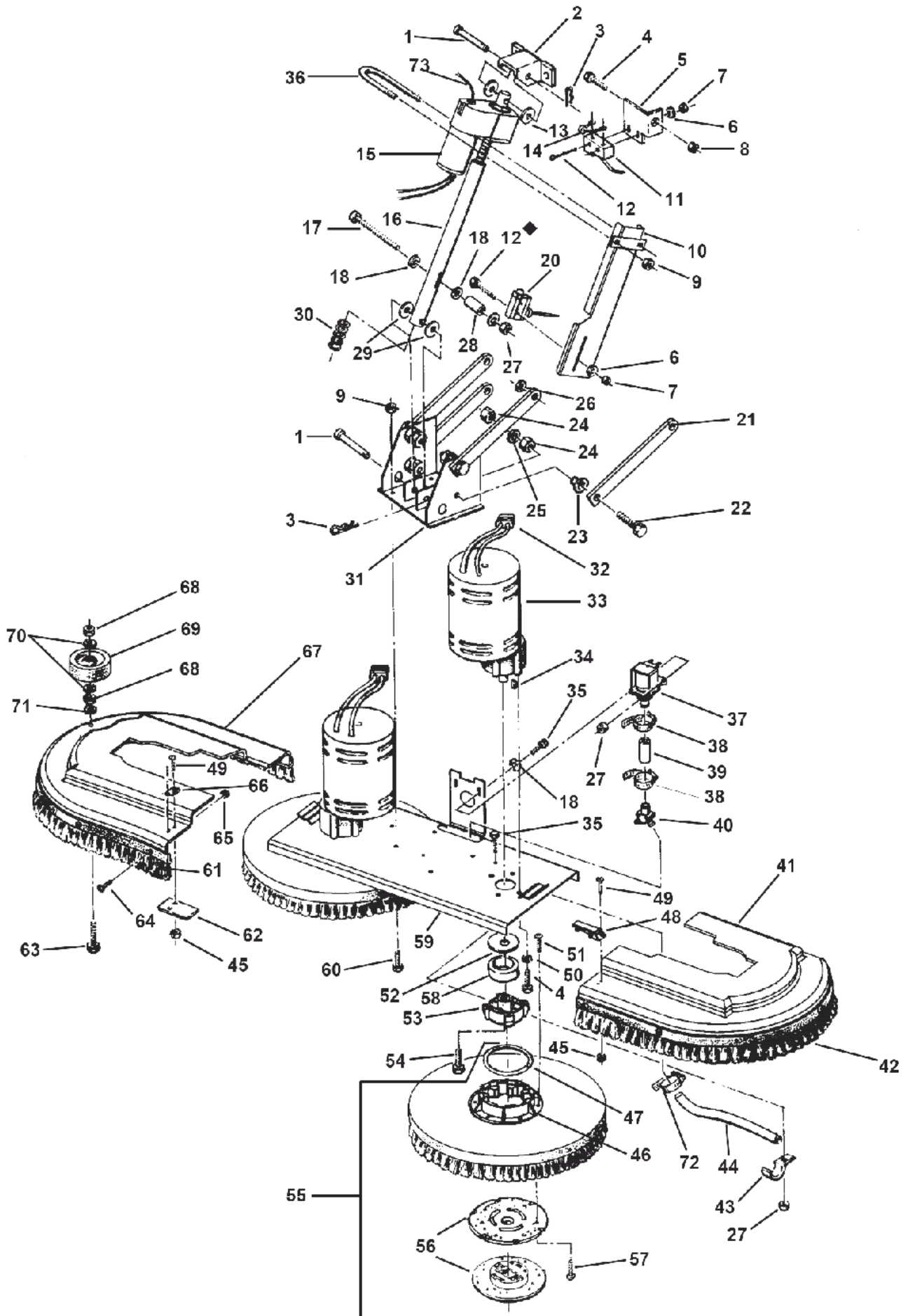

Brush head

ENCORE 28, 33, 38

16-10-2014

Part List ID
ENCORE2806

9

Pos	Part no.	Qty	Description	
1	82501A	2	PIN.CLEVIS.3200 STD SII	
2	60230A	1	MAIN FRAM WELDMENT (ENC)	
3	766780	2	PIN-HANDLE LOCK	
4	962244	9	SCREW 3/8-16 X 3/4 HX HAD	
6	980608	4	#8 FLAT STEEL WASHER	
7	920056	4	NUT-6X32 ELASTIC STOP	
8	81105A	1	NUT. 3/8-16. ESNA TYPE SS	
9	920110	6	NUT.LK 5/16-18 REG(PLTD)	
10	65972A	1	MOUNT WELDMENT SWITCH (EN CORE)	
11	47374A	1	SWITCH. STRAIGHT LEVER 24	
12	962980	4	SCR 6-32X1 PN*ST MACH	
13	38708A	2	SPACER.BRUSH END. EXT-210	
14	42401A	1	DIODE ASM-CONTACTOR	L SERIES
15	50208A	1	ACTUATOR BRUSH	S SERIES
15	50209A	1	ACTUATOR ASM HEAD (ENCORE L33)	L SERIES (INCLUDES ITEM #73)
16	69188A	1	TUBE, PRESSURE	
17	85744A	1	SCREW 1/4 20X2 3/4 HEX HD	
18	87007A	5	WASHER-CONTROL SHAFT ECCE	
19		1	NOTE COMMENT	
20	47422C	1	SWITCH SPRING ROD SPDT	
21	63032A	4	BAR. LINKAGE (IS 66)	
22	85838A	8	SCREW 1/2 UNC X 1.5	
23	67705B	8	BEARING. SLEEVE. 32 AUTO	
24	920278	16	NUT 1/2 - 20 JAM SS	
25	980626	8	1/2 LOCKWASHER LIGHT SERI	
26	980673	4	WASHER.FLT 1/2 ID X 7/8 O D	
27	81104A	5	NUT. 1/4-20. ESNA TYPE SS	
28	38725A	1	SPACER VAC MOTOR ENCORE 28 38	
29	38723A	2	WASHER FLT 1.00X.632X.185 NYLO	
30	53421A	1	SPRING HEAD PRESSURE ENCO	L SERIES
30	53422A	1	SPRING,HEAD PRESSURE (ENC	S SERIES
31	65966A	1	HEAD MOUNT WELDMENT (ENC 33)	
32	40645A	4	CONNECTER HOUSING PP75 BL ACK	
32	41601A	4	CONNECTOR-CONTACT	
33	45036B	2	MOTOR BRUSH 1 OHP 36VDC	
34	915102	2	KEY 1/4X1/4X31/32 SQ	
35	170915	4	SCREW.1/4-20 X 3/4 HX HD(SS)	
36	80044A	1	BOLT U 5/16 18 ZC	
37	48703A	1	VALVE SOLUTION ELECT	
38	50248A	2	CLAMP, 3/8 HOSE	
39	30455A	1	CLEAR VINYL HOSE (ENC 28. 38)	
40	38014A	1	SOLUTION SPLITTER	
41	35244B	1	HOUSING.BRUSH LH (ENCORE 33)	33

Brush head

ENCORE 28, 33, 38

16-10-2014

Part List ID
ENCORE2806

10

Pos	Part no.	Qty	Description	
41	35246B	1	LH BRUSH HOUSING (ENC 38)	38
41	35250B	1	HOUSING.BRUSH LH (ENCORE 28)	28
42	38242A	1	SKIRT LEFT	28
42	38244A	1	BRUSH SKIRT HOUSING LH (ENC 33)	33
42	38246A	1	SKIRT LEFT	38
43	782002	2	CLAMP-MANIFOLD RM-10	
44	30453A	2	SOL. HOSE BRUSH	
45	81109A	4	HEX ELASTICK LOCK NUT SS. 8	
46	833802	2	GIMBAL-BRUSH	
47	838301	2	SPRING-BRUSH HOLDER	
48	55721A	1	LATCH.BRSH.HSG. (ENCORE 2 8-38)	
49	962992	4	SCR 8-32X 5/8 PN*ST	
50	980638	8	LOCKWASHER 3/8 LT SPRING	
51	962495	6	SCREW 1/4-20 X 1 PAN HEAD	
52	59856A	2	WASHER.FLAT RUBBER.3/4 X	
53	34400B	2	GIMBAL.MOTOR.2000/2400 LE	
54	962714	2	SCR 5/16-18X 3/4 SC ST	
55	11424B	2	BRUSH ASM..POLYPROPYLENE	33
55	11425B	2	BRUSH ASM.. GRIT HEAVY (1	33
55	11426B	2	BRUSH ASM.. GRIT HEAVY (28
55	11427B	2	BRUSH ASM..POLYPROPLENE 1	28
55	11433B	2	BRUSH ASM.. GRIT HEAVY (38
55	11434B	2	BRUSH ASM. POLYPROP.19in	38
55	38034A	2	DRIVER PAD 17 GIMBAL	33
55	38036A	2	DRIVER PAD 14IN GIMBAL	28
55	38038A	2	DRIVER PAD 19 GIMBAL	38
56	56941A	2	PAD HOLDER PINCH CLIP	(PAD DRIVER ONLY)
57	962737	6	SCREW#8X5/8 PAN HD.SS	(PAD DRIVER ONLY)
58	61658A	2	COLLAR. RUSH DRIVER (26/3	
59	66232A	1	PLATE WELDMENT BRUSH (ENC 28)	28
59	66233A	1	PLATE WELDMENT BRUSH	33
59	66234A	1	BRUSH PLATE WELDMENT (ENC 38)	38
60	85811A	4	SCREW.5/16-18 X 3/4 HX HD	
61	38243A	1	SKIRT RIGHT	28
61	38245A	1	BRUSH SKIRT HOUSING RH(ENC 33)	33
61	38247A	1	SKIRT RIGHT	38
62	69186A	1	TAB LATCH BRUSH	
63	85610A	1	SCREW. .375-16 X 2.50 PN PH SS	
64	85616A	11	SCREW 10-32 X 5/8 PAN HD SS	28, 33, 38
65	82004A	12	NUT - SKIRT	28, 33, 38
66	55451A	1	BRUSH KEEPER HOUSING ENC 28/38	
67	30245A	1	BRUSH HSG. RIGHT ENCORE 2	L28, S28
67	30246A	1	RH BRUSH HOUSING (ENC L33)	L33, S28

Brush head

ENCORE 28, 33, 38

16-10-2014

Part List ID
ENCORE2806

11

Pos	Part no.	Qty	Description	
67	30247A	1	BRUSH HSG RIGHT ENCORE 38	L38, S28
68	920248	2	NUT 3/8-16 ESNA LIGHT	
69	59950A	1	WHEEL. GUIDE (26/32 VISIO	
70	980645	2	WASHER. 3/8 FLAT SAE	
71	980638	1	LOCKWASHER 3/8 LT SPRING	
72	722021	2	CLAMP.HOSE #4	
73	46742A	1	HEAD PRESSURE SENSOR	L SERIES
NI	71017A	2	LABEL MOVING PARTS	
NI	77352A	1	LABELFRONT MOTOR ENCORE L33	L SERIES
NI	77353A	1	LABEL FRONT MOTOR ENCORE S33	S SERIES

Solution recovery system

ENCORE 28, 33, 38

16-10-2014

Part List ID
ENCORE2808

12

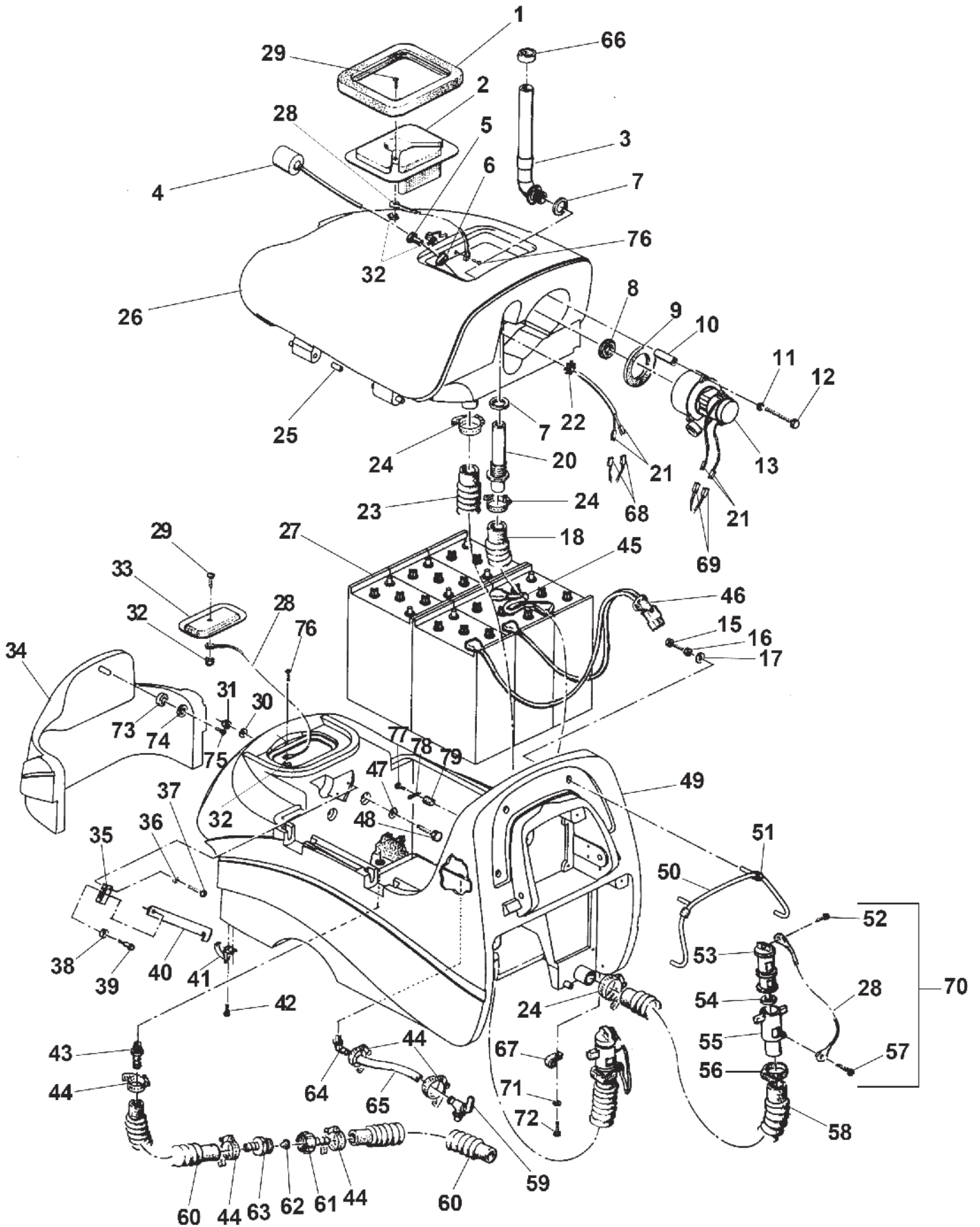

Solution recovery system

ENCORE 28, 33, 38

16-10-2014

Part List ID
ENCORE2808

13

Pos	Part no.	Qty	Description	
1	34265B	1	GASKET RECOVERY AUTOSCRUB	
2	36204C	1	LID. RECOVERY (LARGE VISI ON)	
3	39338B	1	TUBE STAND (ENCORE 28-38)	
4	40002A	1	SWITCH.FLOAT.ELECTRICAL	(INCLUDE #5 & 2 EACH #21 & #68)
5	56459A	1	STRAIN RELIEF EXT-771 PBI	
6	87612A	1	SEAL.WASHER.1700 BT II	
7	837304	2	O'RING. RETAINER. PAPER B	
8	920797	1	NUT DRAIN VALVE LOCK #813	RECOMMENDED TORQUE175 5 INCH/ POUNDS.
9	643418	1	GASKET	
10	58533A	3	SPACER.VAC MOTOR.3 STG. (
11	87026A	3	WASHER. .250. FLAT. SS	
12	85728A	3	SCREW.1/4-20 X4 HEX HD A	
13	56109731	1	MOTOR VAC 36VDC	(ALSO ORDER 2 EACH #21 AND #69)
14	77365B	1	LABELBATTERY ENCORE	
15	85815A	4	SCREW.5/16-18 X 1.50 HEX	
16	980652	4	WASHER.LK 5/16 REG(PLTD)	
17	980205	4	WASHER	
18	35192A	1	HOSE RECOVERY EXT 2100	
19	71014A	1	LABEL FALLING PARTS	
20	30133A	1	TIBE SQ. ADAPTER	
21	41809A	4	CONTACT. CONNECTOR (VISIO	
22	82100A	1	LOCKNUT 1/2in CONDUIT	
23	35165A	1	DRAIN HOSE	
24	872010	3	CLAMP HOSE	
25	36903A	4	HINGE PIN	
26	30260A	1	RECOVERY TANK 38.33.28 BL UE	INCL #25
27	40136A	6	BATTERY 6 VOLT 242AH	
27	891384	6	BATTERY 310 AMP WET	
28	38020A	4	STRAP	
29	962798	2	SCR 10-24X 1/2 PN*SS	
30	980645	2	WASHER. 3/8 FLAT SAE	
31	81105A	2	NUT. 3/8-16. ESNA TYPE SS	
32	920296	4	10-24 ELASTIC STOP NUT	
33	36200A	1	LID. SOLUTION TANK AUTOSC	
34	32409B	1	BLUE FRONT COVER (ENC 28/ 38)	28, 33
34	32419B	1	COVER,FRONT BLUE(ENCORE 2	38
35	61713A	1	BRACKET, TANK SUPPORT	
36	170892	2	WASHER.LK 1/4 REG(SS)	
37	170915	2	SCREW.1/4-20 X 3/4 HX HD(SS)	
38	87622A	1	WASHER FLT .63 X .32 X .0 3 NY	
39	80043A	1	BOLT SHOULDER 5/16 ZC	
40	69548A	1	SUPPORT RECOVERY TANK	
41	55723A	2	LATCH FRONT COVER	

Solution recovery system

ENCORE 28, 33, 38

16-10-2014

Part List ID
ENCORE2808

14

Pos	Part no.	Qty	Description
42	962027	4	SCREW. 8-32 X 1/2 PAN HD
43	50359A	1	ADAPTOR
44	722030	6	CLAMP.HOSE #6
45	41206A	2	CABLE-SERIES.BATTERY. 16in
45	842406	3	CABLE-SERIES
46	41208A	1	CABLE ASM..BATTERY. 32DLX
47	87054A	2	WASHER FENDER 375
48	85703A	2	SCR 3/8 -16X1&1/2 HX ST CAP
49	30259A	1	TANK,SOL ENCORE 38,33,28
50	64900A	1	HANDLE STATIONARY (HANDLE)
51	30454A	2	HOSE CLEAR VINYL ENCORE 28 38
52	962987	2	SCR 10-24X 3/8 PN*ST TY
53	833901	2	HANDLE-DRAIN VALVE
54	833407	2	GASKET-DRAIN
55	839401	2	VALVE-DRAIN
56	832002	2	CLAMP-DRAIN VALVE
57	962958	2	screw
58	30449A	1	HOSE DRAIN-SOLUTION
59	59614A	1	BATTERY DRAIN VALVE (ENC 33)
60	30445A	2	HOSE SOLUTION
61	50358A	1	ADAPTOR SOLUTION TANK
62	838517	1	SCREEN-HOSE WASHER
63	830214	1	ADAPTER-.75 BARB & GHT MA
64	822802	1	ELBOW SOL HOSE TB20E
65	30453A	1	SOL. HOSE BRUSH
66	58069A	1	SCREEN VAC FILTER ENCORE
67	98465A	1	INSUL METAL CLAMP 7/8
68	43402A	2	HOUSING. CONNECTOR (BLU)
69	43401A	2	HOUSING. CONNECTOR (BLK)
70	839410	1	VALVE ASSY
71	980657	1	WASHER.LK 1/4 STD
72	962139	1	SCREW 1/4-20 X 5/8 HEX HD
73	39713A	1	RUBBER WASHER
74	87032A	1	PLAIN WASHER 1/4 NOM
75	85524A	1	SCREW 1/4 - 14 X 3/4 PN H D
76	962666	2	SCREW 10-24X 3/4 PAN HEAD PHIL
77	962113	1	SCREW 10-32X1 RD ST MACH
78	51867A	1	CLAMP CABLE 1/2 IN. NYLON
79	81800A	1	WELL NUT
80	71015A	1	LABEL GASES CHEMICALS

Brush motor

ENCORE 28, 33, 38

16-10-2014

Part List ID
ENCORE2810

15

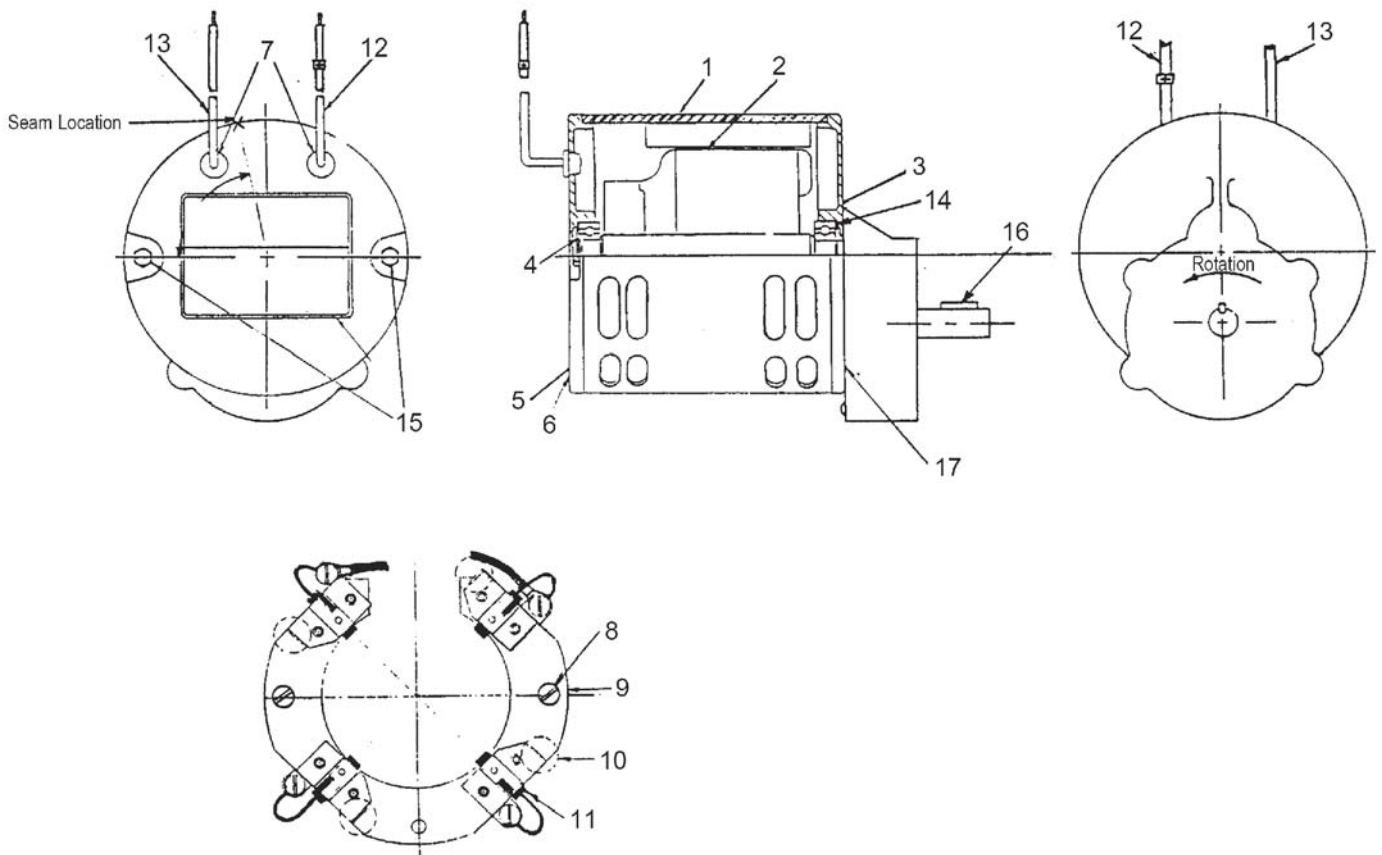

Brush motor

ENCORE 28, 33, 38

16-10-2014

Part List ID
ENCORE2810

16

Pos	Part no.	Qty	Description	
1	46734A	1	STATOR ASM.	45036A
1	56478A	1	STATOR ASM	45033A
2	40312A	1	ARMATURE ASM..(FOR P/N 45	45033A
2	40318A	1	ARMATURE ASM.	45036A
3	902654	1	BEARING	
4	902550	1	BEARING	
5	51840A	1	COMMUTATOR ASM. BRACKET 1700/	
6	50520A	1	BRACKET COMMUTATOR 1700/2000	
7	56480A	2	STRAIN RELIEF MOTOR 1700/2000	
8	962546	2	SCR 10-24X 1/2 PN*ST TY	
9	50517A	1	BOARD. ASM. BRUSH 1700/20	
10	448396	4	SPRING-BRUSH #571001	
11	40826A	4	BRUSH ASM.CARBON (V32I/26	
12	55657A	1	LEAD ASM POSTIVE FOR MTR NO.44	
13	55656A	1	LEAD ASM NEGATIVE FOR MTR NO.4	
14	59805A	1	WASHER-HELICAL	
15	50515A	2	BOLTTHRU 1/4-20 X 7 5/8 HEX H	
16	80501A	1	KEY. MTR SHAFT-3/16SQ X 1 1/4L	
17	54238A	1	GEARBOX ASSEMBLY 1700/200	

Gear box #54238A

ENCORE 28, 33, 38

16-10-2014

Part List ID
ENCORE2812

17

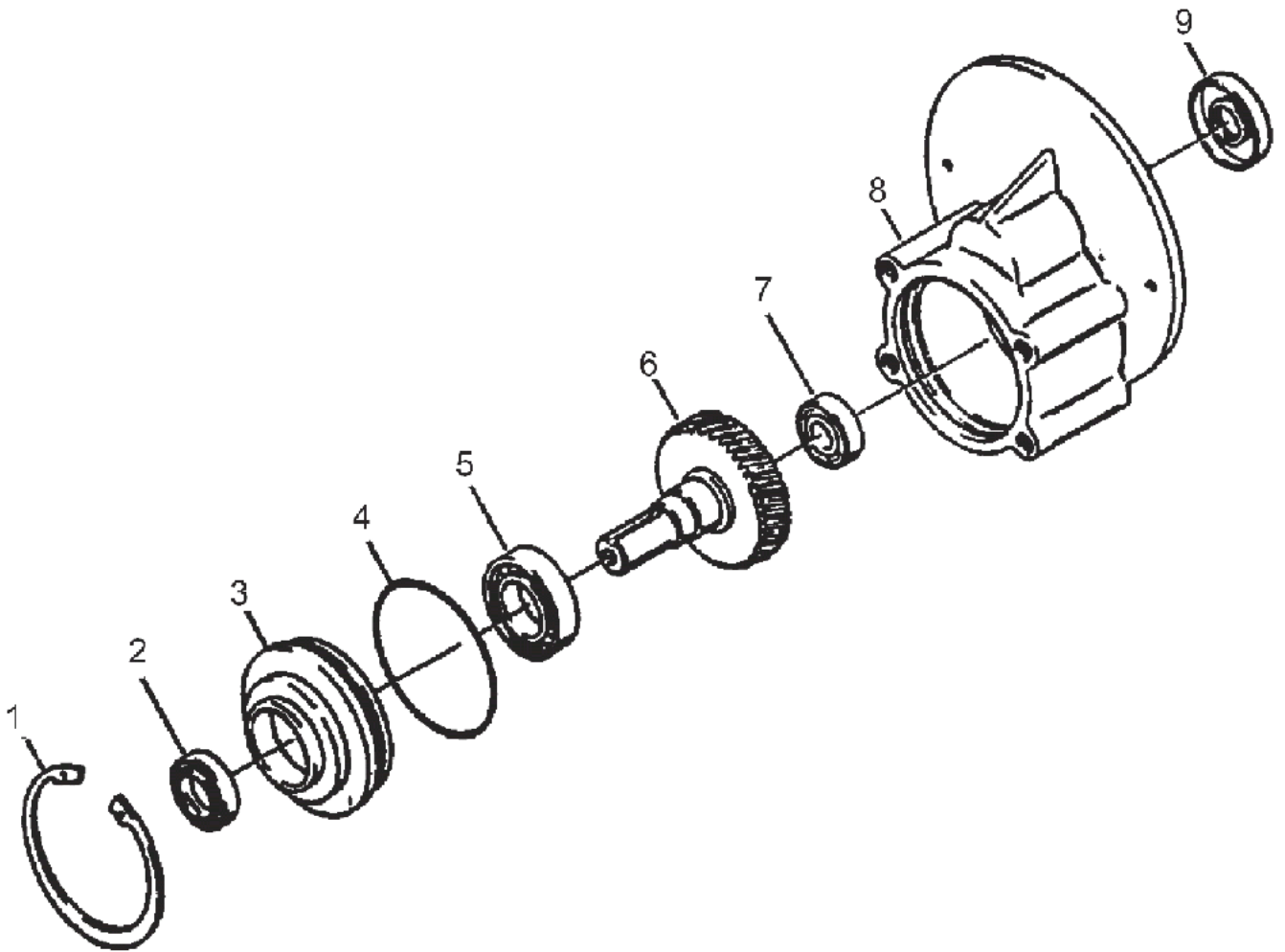

Gear box #54238A

ENCORE 28, 33, 38

16-10-2014

Part List ID
ENCORE2812

18

Pos	Part no.	Qty	Description
1	57846A	1	RING KIT.SNAP.INTERNAL.GE
2	507641	1	SEAL.OIL-0.875 X 1.375 X
3	52050A	1	CAP. END. GEAR BOX 1700/2
4	56668A	1	O-RING. GEARBOX. (1700/20
5	51176A	1	BEARING. BALL 6005 SERIES
6	58316A	1	SHAFT AND GEAR. GEARBOX 1
7	902605	1	BRG 710 730 TB16 TB18
8	54883A	1	HOUSING. GEARBOX. 1700/20
9	58144A	1	SEAL. OIL 1.628 OD X .75

Vac motor #45019A

ENCORE 28, 33, 38

16-10-2014

Part List ID
ENCORE2814

19

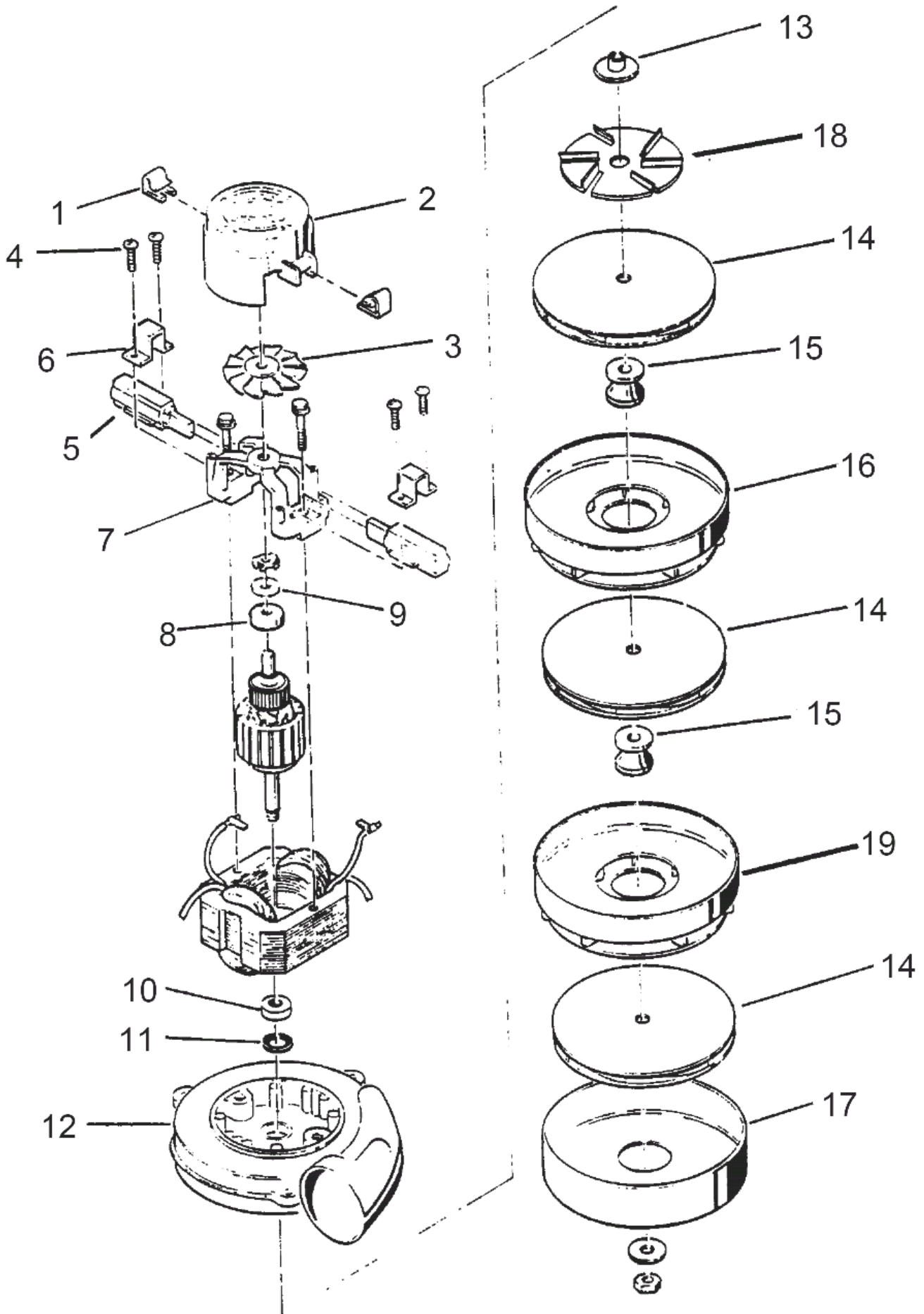

Vac motor #45019A

ENCORE 28, 33, 38

16-10-2014

Part List ID
ENCORE2814

20

Pos	Part no.	Qty	Description
1	51913A	2	CLIP
2	54809A	1	HOUSING
3	53905A	1	FAN-VENT (685202-4)
4	85303A	4	SCR 8-32X 3/8 PN*ST MA
5	40830A	2	BRUSH.CARBON (GREEN HOUSI
6	51914A	2	CLAMP
7	50618A	1	BRACKET-END COMM.
8	53100A	1	DISC
9	902679	1	BEARING-BALL
10	902648	1	BRG-BALL.RADIAL.DBL SEAL
12	50610A	1	BRACKET-END. FAN (FOR 835
13	58501A	1	SPACER
14	53914A	3	FAN
15	658201	2	SPACER
16	53908A	1	FAN-STATIONARY
17	658506	1	SHELL-FAN
19	53996A	1	FAN STATIONARY

Transaxle parts

ENCORE 28, 33, 38

16-10-2014

Part List ID
ENCORE2816

21

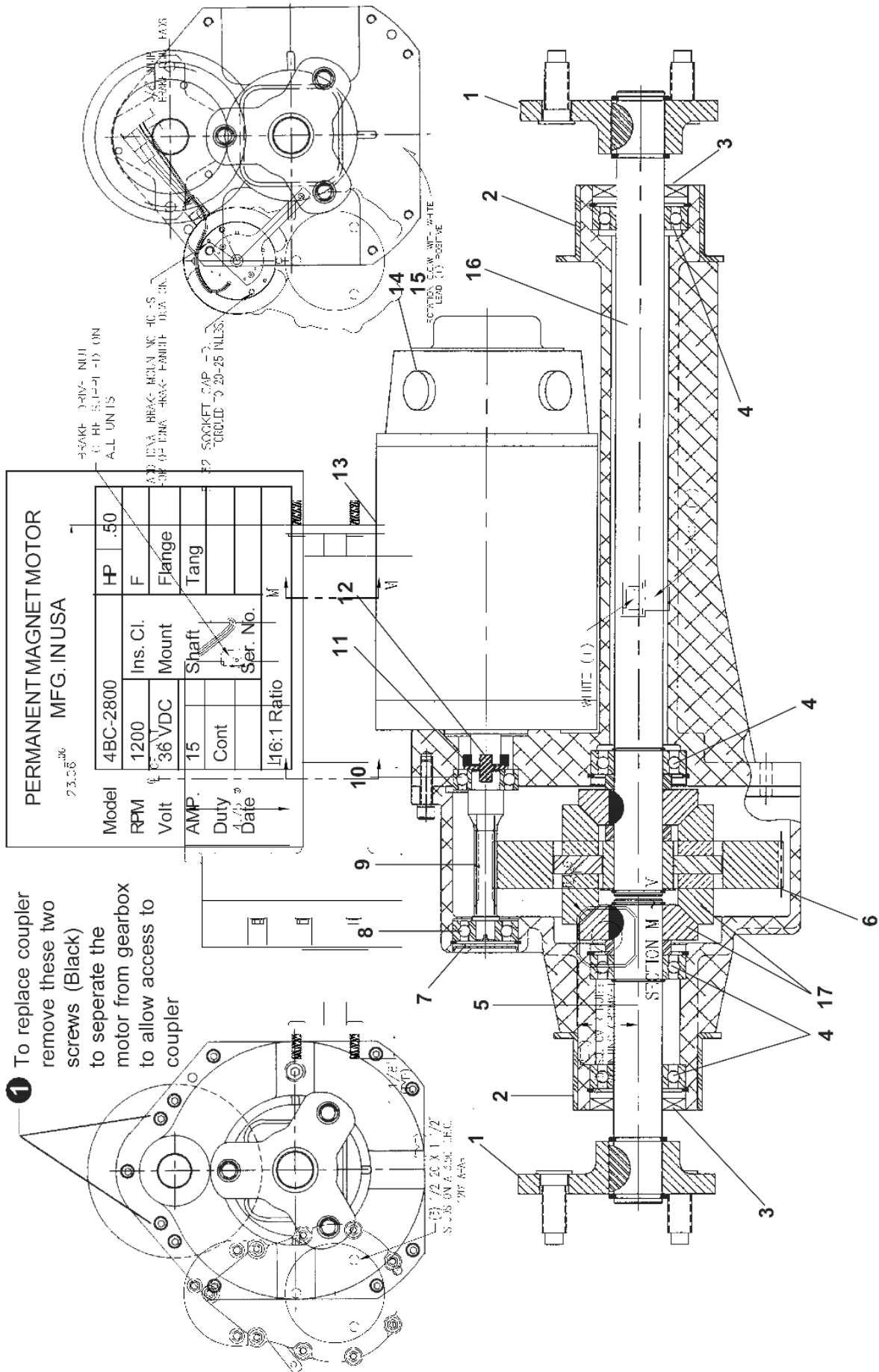

Transaxle parts

ENCORE 28, 33, 38

16-10-2014

Part List ID
ENCORE2816

22

Pos	Part no.	Qty	Description	
-	53384A	1	PAD FRICTION FOR BRAKE 51201D	SPARE PART PARKING BRAKE
-	53385A	1	HUB SHAFT FOR BRAKE 51201D	SPARE PART PARKING BRAKE
-	54282A	1	TRANSAXLE GEARBOX ASSEMBLY	
1	10357A	2	WHEEL FLANGE KIT	
2	36508A	2	MOUNT,RUBBER FOR 59116A	
3	53374A	2	SEALOIL CR10124 LARGE ENCORE	
4	53375A	4	BEARING R16 SEALED LARGE ENC	
5	53376A	1	AXLE SHORT LARGE ENCORE	
6	53377A	1	GEAR OUTPUT LARGE ENCORE	
7	53378A	1	PLUG INPUT LARGE ENCORE	
8	53379A	1	BEARING 6300-ZZ LARGE ENCORE	
9	53380A	1	PINION LARGE ENCORE	
10	53381A	1	BEARING 6202-2RS LARGE ENCORE	
11	52663A	1	SPACER COUPLER FOR 59116A	
12	69195A	1	TRANSAXLE COUPLER FOR 591 16A	
13	45048A	1	MOTOR.TRANSAXLE	
14	51720A	1	CARBON BRUSH (4) FOR 4504 8A	
15	30074A	4	BRUSH CAP	Internal threads
15	53382A	4	CAP, BRUSH EXT THD(LARGE	External threads
16	53383A	1	AXLE, LONG (LARGE ENCORE)	
17	53435A	4	GEAR MILTER IMPERIAL	

Control housing

ENCORE 28, 33, 38

16-10-2014

Part List ID
ENCORE2820

23

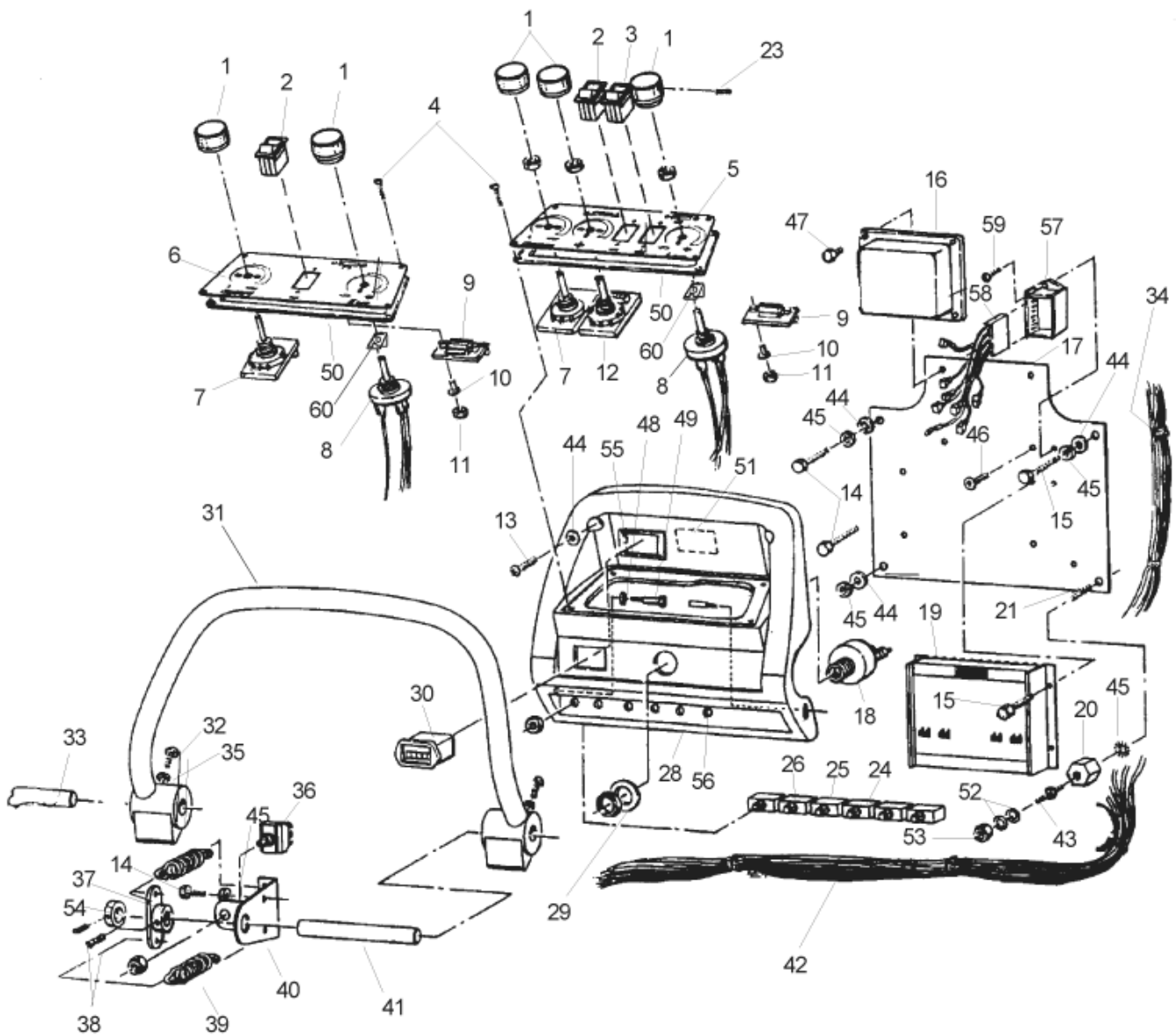

Control housing

ENCORE 28, 33, 38

16-10-2014

Part List ID
ENCORE28&30

24

Pos	Part no.	Qty	Description	
1	55502A	3	SPEED CONTROL KNOB	L SERIES
2	47381B	1	SWITCH. DPDT 15A 3/4 HP N L RKR	
3	47383A	1	SWITCH.3 POSITION.ROCKER(L SERIES
4	85612A	6	SCREW	
6	60058A	1	PANEL WLD	S SERIES
6	77343B	1	LABEL,CONSOLE ENCORE S	S SERIES
7	44308B	1	CONTROL. SOLUTION	
8	40622A	1	HARNESS TRAVERSE L28-38	L SERIES
8	40623A	1	HARNESS, TRAVERSE S28-38	S SERIES
9	44416B	1	METER.BATTERY	
10	38724B	2	WASHER NYLON SHOULDER	
11	920056	2	NUT-6X32 ELASTIC STOP	
12	50170A	1	BRUSH PRESSURE ADJUST	L SERIES
13	85391A	2	SCR 1/4 -20X 5/8 PN*SY	
14	962139	5	SCREW 1/4-20 X 5/8 HEX HD	L SERIES
15	962139	2	SCREW 1/4-20 X 5/8 HEX HD	S SERIES
15	962992	4	SCR 8-32X 5/8 PN*ST	L SERIES
16	41153A	1	ACTUATOR CONTROL BOARD	L SERIES
18	47380A	1	SWITCH.KEY. 32DLX/STD	
19	41154A	1	BR.PRESS.CONTROL BOARD	L SERIES
20	854849	1	INSULATOR RO-42/32IX/26IX	
21	170781	1	SCR 1/4 -20X 3/4 ST	
22	41431B	2	CIRCUIT BREAKER-35A.SCR.T ERM.	
23	962262	3	SCR 8-32X 1/4 ST ST CUP	L SERIES
23	962262	2	SCR 8-32X 1/4 ST ST CUP	S SERIES
24	41448B	1	BREAKER. CIRCUIT 30A PUSH BTTN	
25	41422B	1	CIRCUIT BREAKER.25A	
26	41423B	1	CIRCUIT BREAKER 5A PUSH B UTTON	
27	41430b	1	BREAKER CIRCUIT 1.5 AMP	L SERIES
28	35243B	1	HOUSING CNTRL.BLUEENCORE28 38	L SERIES
28	35252B	1	HOUSING.CNTRL.BLUE(ENCORE 28-38	S SERIES
29	87052A	1	FLAT NYLON WASHER 1.25 X1 X.02	
30	912226	1	METER. HOUR- 12V DC	
31	24309B	1	HANDLE CONTROLENCORE 28 33 38	
32	85390A	2	SCR 1/4 -20X1&1/4 PN*SS	
33	66549A	1	PIN CENTRAL HANDLE RH ENC ORE	
34	49778A	1	WIRE HARNESS HD ACT (ENC L)	L SERIES
35	170892	2	WASHER.LK 1/4 REG(SS)	
36	10052A	1	KIT SWITCH WITH INSTRUCTI ONS	
37	60662A	1	CENTERING ASM BRACKET	
38	962304	1	SCR 5/16-18X 1/2 ST ST	
39	53038A	4	SPRING. TENSION (LARGE AU	
40	61266A	2	BRACKET WLDMNT CNTLENCORE 33	

Control housing

ENCORE 28, 33, 38

16-10-2014

Part List ID
ENCORE2830

25

Pos	Part no.	Qty	Description	
41	66548A	1	PIN CENTRAL HANDLE RH ENC ORE	
42	49777A	1	WIRE HARNESS L CLASS (ENC ORE)	L SERIES
42	49779A	1	WIRE S CLASS HARNESS (ENC)	S SERIES
43	83302A	1	STUD 1/4-20	
44	87007A	2	WASHER-CONTROL SHAFT ECCE	S SERIES
44	87007A	5	WASHER-CONTROL SHAFT ECCE	L SERIES
45	980657	6	WASHER.LK 1/4 STD	L SERIES
45	980657	3	WASHER.LK 1/4 STD	S SERIES
46	54763A	8	INSERTHEX 8-32 UNC ENCORE	L SERIES
47	85613A	4	SCREW8-32X7/8 PAN HD	L SERIES
48	980651	1	WASHER. 5/16 SAE FLAT	
49	80043A	1	BOLT SHOULDER 5/16 ZC	
50	30022A	1	GASKETPANEL ENCORE S 28 38	S SERIES
50	30025A	1	GASKET,PANEL (ENCORE L28-	L SERIES
51	77351B	1	LABELPANELCONTROL S28 38	S SERIES
52	87026A	2	WASHER. .250. FLAT. SS	
53	81104A	1	NUT. 1/4-20. ESNA TYPE SS	
54	61651A	1	CONTROL SWITCH COLLAR 32	
55	66871A	1	RETAINERSWITCH ENCORE 28 38	
56	60042A	1	STUD.31 OD X 1/4 20 THD.	
57	40083B	1	SEQUENCER MODULE (LGE ENC ORE)	
58	40085A	1	HARNESS WIRE SW/SEQ (LGE ENC)	
59	85388A	2	SCR 10-24X 1/2 PN*SB	L SERIES
60	50883A	1	RETAINER POTENTIOMETER 5K	
18A	55413A	1	KEY (26/32 VISION)FOR 473	

Rear cover

ENCORE 28, 33, 38

16-10-2014

Part List ID
ENCORE2822

26

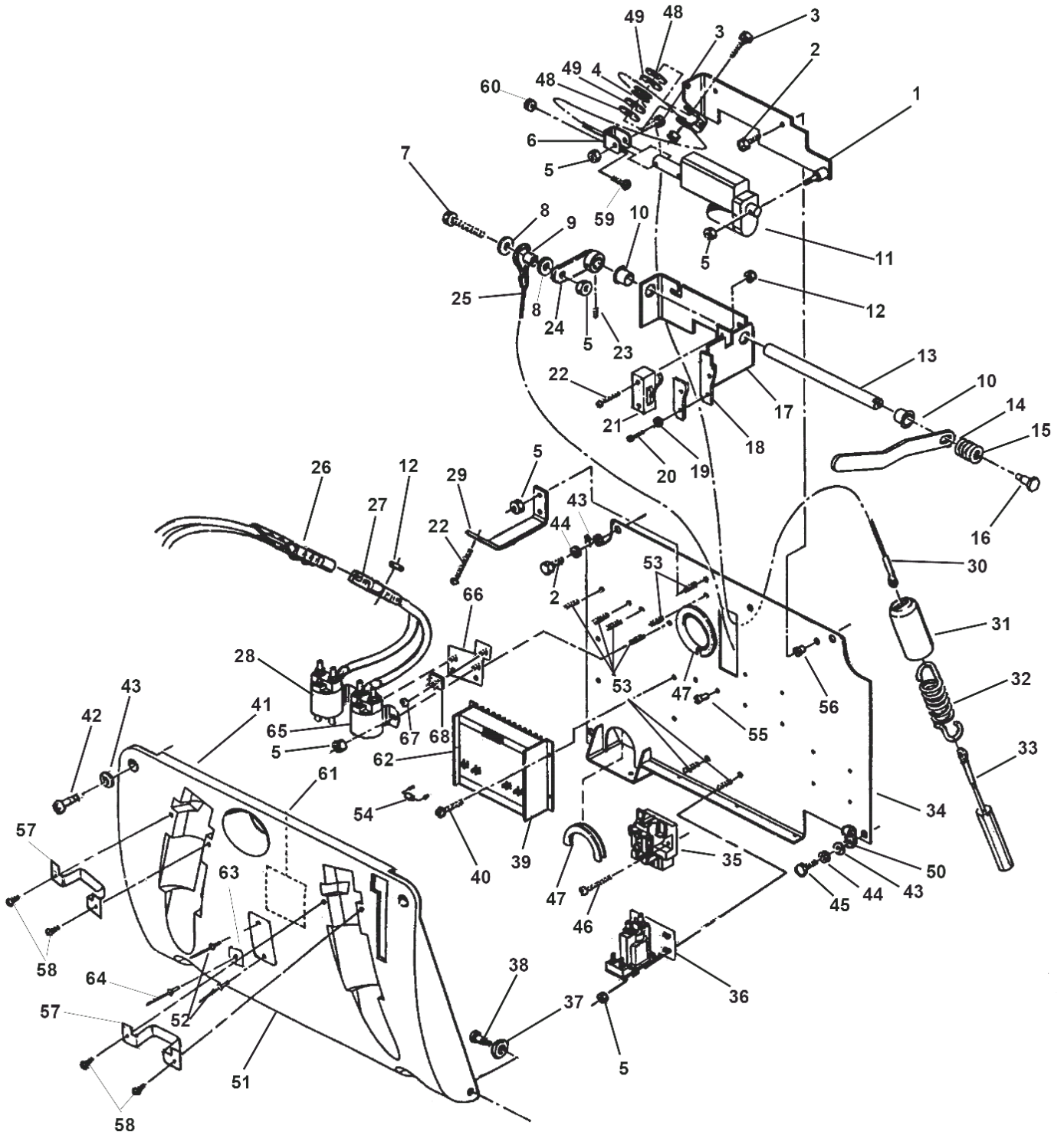

Rear cover

ENCORE 28, 33, 38

16-10-2014

Part List ID
ENCORE28ZZ

27

Pos	Part no.	Qty	Description	
1	61264A	1	BRACKET WLD SQUG ACT (ENC)	L SERIES
2	962139	5	SCREW 1/4-20 X 5/8 HEX HD	
3	86004A	2	SCREW 1/4 CLAMP SQ.	L SERIES
4	57275A	1	PULLEY	L SERIES
5	81104A	11	NUT. 1/4-20. ESNA TYPE SS	L SERIES
5	81104A	9	NUT. 1/4-20. ESNA TYPE SS	S SERIES
6	69872A	1	BRACKET PULLEY PLTDENCORE	L SERIES
7	85700A	1	SCR 1/4 -20X1 HX ST CAP	S SERIES
8	87026A	2	WASHER. .250. FLAT. SS	S SERIES
9	608210	1	SPACER-HANDLE BOLT	S SERIES
10	902731	2	BEARING-NYLINER	S SERIES
11	40102B	1	ACTUATOR	L SERIES
12	920056	2	NUT-6X32 ELASTIC STOP	L SERIES
12	920056	4	NUT-6X32 ELASTIC STOP	S SERIES
13	67476A	1	SHAFT.SQUEG LIFT (ENCORE 28-38	S SERIES
14	65629A	1	LEVER.SQUG. LIFT(ENCORE 3 3)	S SERIES
15	438360	1	SPRING-ADJUSTER LIFT	S SERIES
16	960510	1	BOLT PIVOT LEVER TB18/32A	S SERIES
17	61265A	1	BRACKET WLD,SQU.LIFT	S SERIES
18	68643A	1	PLATE, WEAR	S SERIES
19	980675	2	WASH-.190IDX.406OD EX TH	S SERIES
20	962546	2	SCR 10-24X 1/2 PN*ST TY	S SERIES
21	47388A	1	SWITCH. ASM. VAC 26/32 VI	S SERIES
22	962980	2	SCR 6-32X1 PN*ST MACH	L SERIES
22	962980	4	SCR 6-32X1 PN*ST MACH	S SERIES
23	962304	2	SCR 5/16-18X 1/2 ST ST	S SERIES, USE ONLY RED LOCTIE
24	65628A	1	LEVER WLDMNT LIFT ENCORE 33	S SERIES
25	61682A	1	CABLE ASM.UPP.ENC.S33	S SERIES
26	41208A	1	CABLE ASM..BATTERY. 32DLX	
27	41140A	1	CABLE ASM.. CONSOLE AUTOS	
28	41801A	2	CONTACTOR 36V	
29	69878A	1	BRACKETPLUG ENCORE 33	
30	61681A	1	CABLE ASSY UPPER	L SERIES
31	58409A	1	SLEEVE SQ LIFT	L SERIES
32	53424A	1	SPRING CABLE SQ LIFT	L SERIES
33	61680A	1	SPRING CABLE ASSEMBLY ENC 33	L SERIES
34	69372A	1	PANEL WLD.REAR LWR. ENCORE 33	
35	46309A	1	RELAY. DPDT. 30A 36VDC	L SERIES
36	40125A	1	SOLENOID FOR VAC MOTOR	
37	980651	2	WASHER. 5/16 SAE FLAT	
38	80043A	2	BOLT SHOULDER 5/16 ZC	
39	41135C	1	CONTROL.MOTOR SOLID STATE 33IX	
40	962992	4	SCR 8-32X 5/8 PN*ST	

Rear cover

ENCORE 28, 33, 38

16-10-2014

Part List ID
ENCORE28ZZ

28

Pos	Part no.	Qty	Description	
41	32410B	1	COVERREAR BLUE ENCORE 28 38	L SERIES
41	32418B	1	COVER.REAR BLUE(ENCORE 28 -38)	S SERIES
42	85391A	2	SCR 1/4 -20X 5/8 PN*SY	
43	87007A	6	WASHER-CONTROL SHAFT ECCE	
44	980657	4	WASHER.LK 1/4 STD	
45	85806A	1	SCREW 1/4-20 X 3/4 HX SZ CAP	
46	85614A	2	SCREW8-32X3/4 PAN HD	L SERIES
47	193951	1	TRIM DOUBLE LIP BLACK	
48	87625A	4	WASHER FLT 1.25X.26X.03N	L SERIES
49	87624A	2	WASHER FLT 1.50X.26X.13N	L SERIES
50	98465A	1	INSUL METAL CLAMP 7/8	
52	930093	2	1/8X1/4-5/16 POP RIVET	
53	83307A	8	STUD 1/4-20 ASS4-420-165-625	
54	42405A	1	DIODE ASSY CONTROL VISION IX	
55	54763A	6	INSERTHEX 8-32 UNC ENCORE	L SERIES
55	54763A	4	INSERTHEX 8-32 UNC ENCORE	S SERIES
56	54764A	2	INSERTHEX1/4-20 UNC ENCORE	
57	60233A	2	HOSE BRACKET(LARGE ENCOR E)	
58	962957	4	SCR 10-16X 1/2 PN*ST HI	
59	962798	1	SCR 10-24X 1/2 PN*SS	L SERIES
60	920296	1	10-24 ELASTIC STOP NUT	L SERIES
62	77194B	1	LABELCONTROLMOTORTRAVERSE	
64	83010A	1	1/8 RIVET	

Controle housing (machines with a 40089A trave

ENCORE 28, 33, 38

16-10-2014

Part List ID
ENCORE2824

29

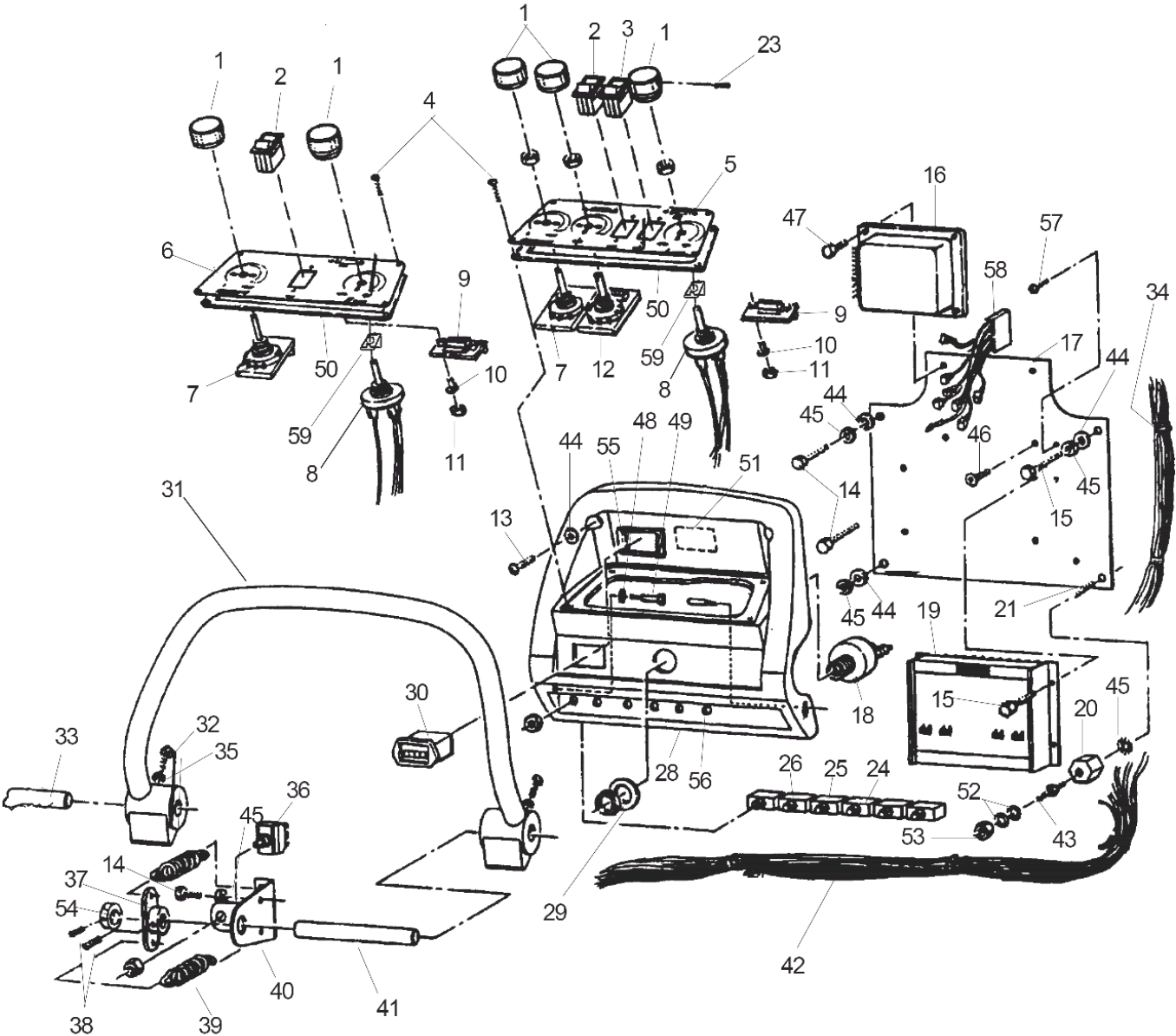

Controle housing (machines with a 40089A travel

ENCORE 28, 33, 38

16-10-2014

Part List ID
ENCORE2834

30

Pos	Part no.	Qty	Description	
1	55502A	2	SPEED CONTROL KNOB	S SERIES
1	55502A	3	SPEED CONTROL KNOB	L SERIES
2	47381B	1	SWITCH. DPDT 15A 3/4 HP N L RKR	
3	47383A	1	SWITCH.3 POSITION.ROCKER(L SERIES
4	85612A	6	SCREW	
6	60058A	1	PANEL WLD	S SERIES
6	77343B	1	LABEL,CONSOLE ENCORE S	S SERIES
7	44308B	1	CONTROL. SOLUTION	
8	40622A	1	HARNESSTRAVERSE L28-38	L SERIES
8	40623A	1	HARNESSTRAVERSE S28-38	S SERIES
9	44416B	1	METER.BATTERY	
10	38724B	2	WASHER NYLON SHOULDER	
11	920056	2	NUT-6X32 ELASTIC STOP	
12	50170A	1	BRUSH PRESSURE ADJUST	L SERIES
13	85391A	2	SCR 1/4 -20X 5/8 PN*SY	
14	962139	5	SCREW 1/4-20 X 5/8 HEX HD	L SERIES
15	962139	2	SCREW 1/4-20 X 5/8 HEX HD	S SERIES
15	962992	4	SCR 8-32X 5/8 PN*ST	L SERIES
16	41153A	1	ACTUATOR CONTROL BOARD	L SERIES
18	47380A	1	SWITCH.KEY. 32DLX/STD	
19	41154A	1	BR.PRESS.CONTROL BOARD	L SERIES
20	854849	1	INSULATOR RO-42/32IX/26IX	
21	170781	1	SCR 1/4 -20X 3/4 ST	
22	41431B	2	CIRCUIT BREAKER-35A.SCR.TERM.	
23	962262	3	SCR 8-32X 1/4 ST ST CUP	L SERIES
23	962262	2	SCR 8-32X 1/4 ST ST CUP	S SERIES
24	41448B	1	BREAKER. CIRCUIT 30A PUSH BTTN	
25	41422B	1	CIRCUIT BREAKER.25A	
26	41423B	1	CIRCUIT BREAKER 5A PUSH BUTTON	
27	41430b	1	BREAKER CIRCUIT 1.5 AMP	L SERIES
28	35243B	1	HOUSING CNTRL.BLUEENCORE28 38	L SERIES
28	35252B	1	HOUSING.CNTRL.BLUE(ENCORE 28-38	S SERIES
29	87052A	1	FLAT NYLON WASHER 1.25 X1 X.02	
30	912226	1	METER. HOUR- 12V DC	
31	24309B	1	HANDLE CONTROLENCORE 28 33 38	
32	85390A	2	SCR 1/4 -20X1&1/4 PN*SS	
33	66549A	1	PIN CENTRAL HANDLE RH ENC ORE	
34	49778A	1	WIRE HARNESS HD ACT (ENC L)	L SERIES
35	170892	2	WASHER.LK 1/4 REG(SS)	
36	10052A	1	KIT SWITCH WITH INSTRUCTIONS	
37	60662A	1	CENTERING ASM BRACKET	
38	962304	4	SCR 5/16-18X 1/2 ST ST	USE ONLY RED LOCTITE
39	53038A	2	SPRING. TENSION (LARGE AU	

Controle housing (machines with a 40089A travel

ENCORE 28, 33, 38

16-10-2014

Part List ID
ENCORE2834

31

Pos	Part no.	Qty	Description	
40	61266A	1	BRACKET WLDMNT CNTLENCORE 33	
41	66548A	1	PIN CENTRAL HANDLE RH ENC ORE	
42	49777C	1	HARNESS ENCORE L28 38 MAIN	L SERIES
42	49779C	1	HARNESS ENCORE S28-38 MAIN	S SERIES
43	83302A	1	STUD 1/4-20	
44	87007A	2	WASHER-CONTROL SHAFT ECCE	S SERIES
44	87007A	5	WASHER-CONTROL SHAFT ECCE	L SERIES
45	980657	6	WASHER.LK 1/4 STD	L SERIES
45	980657	3	WASHER.LK 1/4 STD	S SERIES
46	54763A	8	INSERTHEX 8-32 UNC ENCORE	L SERIES
47	85613A	4	SCREW8-32X7/8 PAN HD	L SERIES
48	980651	1	WASHER. 5/16 SAE FLAT	
49	80043A	1	BOLT SHOULDER 5/16 ZC	
50	30022A	1	GASKETPANEL ENCORE S 28 38	S SERIES
50	30025A	1	GASKET,PANEL (ENCORE L28-	L SERIES
51	77351C	1	LABEL PANEL CONTROL S28-38	S SERIES
52	87026A	2	WASHER. .250. FLAT. SS	
53	81104A	1	NUT. 1/4-20. ESNA TYPE SS	
54	61651A	1	CONTROL SWITCH COLLAR 32	
55	66871A	1	RETAINERSWITCH ENCORE 28 38	
56	60042A	1	STUD.31 OD X 1/4 20 THD.	
57	85388A	2	SCR 10-24X 1/2 PN*SB	L SERIES
58	40622A	1	HARNESS TRAVERSE L28-38	L SERIES
58	40623A	1	HARNESS, TRAVERSE S28-38	S SERIES
59	50883A	1	RETAINER POTENTIOMETER 5K	
NI	42909A	2	FUSE.5A.250V.616/620 EURO	
18A	55413A	1	KEY (26/32 VISION)FOR 473	

Rear cover (machines with a 40089A traverse coil)

16-10-2014

Part List ID
ENCORE2826

ENCORE 28, 33, 38

32

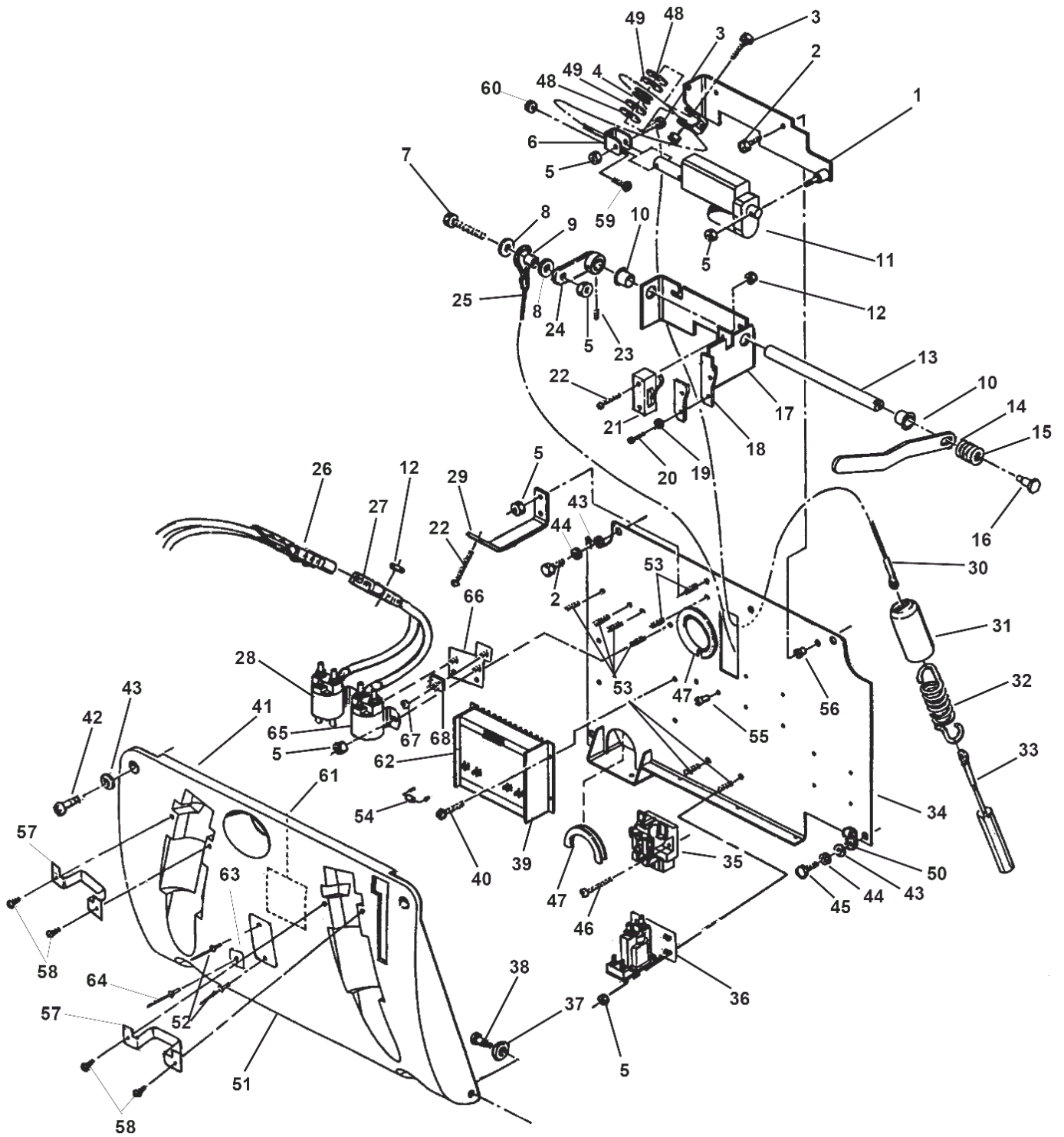

Rear cover (machines with a 40089A traverse co

ENCORE 28, 33, 38

16-10-2014

Part List ID
ENCORE2826

33

Pos	Part no.	Qty	Description	
1	61264A	1	BRACKET WLD SQUG ACT (ENC)	L SERIES
2	962139	5	SCREW 1/4-20 X 5/8 HEX HD	
3	86004A	2	SCREW 1/4 CLAMP SQ.	L SERIES
4	57275A	1	PULLEY	L SERIES
5	81104A	11	NUT. 1/4-20. ESNA TYPE SS	L SERIES
5	81104A	9	NUT. 1/4-20. ESNA TYPE SS	S SERIES
6	69872A	1	BRACKET PULLEY PLTDENCORE	L SERIES
7	85700A	1	SCR 1/4 -20X1 HX ST CAP	S SERIES
8	87026A	2	WASHER. .250. FLAT. SS	S SERIES
9	608210	1	SPACER-HANDLE BOLT	S SERIES
10	902731	2	BEARING-NYLINER	S SERIES
11	40102B	1	ACTUATOR	L SERIES
12	920056	2	NUT-6X32 ELASTIC STOP	L SERIES
12	920056	4	NUT-6X32 ELASTIC STOP	S SERIES
13	67476A	1	SHAFT.SQUEG LIFT (ENCORE 28-38	S SERIES
14	65629A	1	LEVER.SQUG. LIFT(ENCORE 3 3)	S SERIES
15	438360	1	SPRING-ADJUSTER LIFT	S SERIES
16	960510	1	BOLT PIVOT LEVER TB18/32A	S SERIES
17	61265A	1	BRACKET WLD,SQU.LIFT	S SERIES
18	68643A	1	PLATE, WEAR	S SERIES
19	980675	2	WASH-.190IDX.406OD EX TH	S SERIES
20	962546	2	SCR 10-24X 1/2 PN*ST TY	S SERIES
21	47388A	1	SWITCH. ASM. VAC 26/32 VI	S SERIES
22	962980	2	SCR 6-32X1 PN*ST MACH	L SERIES
22	962980	4	SCR 6-32X1 PN*ST MACH	S SERIES
23	962304	2	SCR 5/16-18X 1/2 ST ST	S SERIES
24	65628A	1	LEVER WLDMNT LIFT ENCORE 33	S SERIES
25	61682A	1	CABLE ASM.UPP.ENC.S33	S SERIES
26	41208A	1	CABLE ASM..BATTERY. 32DLX	
27	41140A	1	CABLE ASM.. CONSOLE AUTOS	
28	41802A	1	CONTACTOR.36V	
29	69878A	1	BRACKETPLUG ENCORE 33	
30	61681A	1	CABLE ASSY UPPER	L SERIES
31	58409A	1	SLEEVE SQ LIFT	L SERIES
32	53424A	1	SPRING CABLE SQ LIFT	L SERIES
33	61680A	1	SPRING CABLE ASSEMBLY ENC 33	L SERIES
34	69372A	1	PANEL WLD.REAR LWR. ENCORE 33	
35	46309A	1	RELAY. DPDT. 30A 36VDC	L SERIES
36	40125A	1	SOLENOID FOR VAC MOTOR	
37	980651	2	WASHER. 5/16 SAE FLAT	
38	80043A	2	BOLT SHOULDER 5/16 ZC	
39	40089A	1	S.STATE TRAVERSE CONTROL 36V	
40	962992	4	SCR 8-32X 5/8 PN*ST	

Rear cover (machines with a 40089A traverse co

ENCORE 28, 33, 38

16-10-2014

Part List ID
ENCORE2826

34

Pos	Part no.	Qty	Description	
41	32410B	1	COVERREAR BLUE ENCORE 28 38	L SERIES
41	32418B	1	COVER.REAR BLUE(ENCORE 28 -38)	S SERIES
42	85391A	2	SCR 1/4 -20X 5/8 PN*SY	
43	87007A	6	WASHER-CONTROL SHAFT ECCE	
44	980657	4	WASHER.LK 1/4 STD	
45	85806A	1	SCREW 1/4-20 X 3/4 HX SZ CAP	
46	85614A	2	SCREW8-32X3/4 PAN HD	L SERIES
47	193951	1	TRIM DOUBLE LIP BLACK	
48	87625A	4	WASHER FLT 1.25X.26X.03N	L SERIES
49	87624A	2	WASHER FLT 1.50X.26X.13N	L SERIES
50	98465A	1	INSUL METAL CLAMP 7/8	
52	930093	2	1/8X1/4-5/16 POP RIVET	
53	83307A	8	STUD 1/4-20 ASS4-420-165-625	
54	42405A	1	DIODE ASSY CONTROL VISION IX	
55	54763A	6	INSERTHEX 8-32 UNC ENCORE	L SERIES
55	54763A	4	INSERTHEX 8-32 UNC ENCORE	S SERIES
56	54764A	2	INSERTHEX1/4-20 UNC ENCORE	
57	60233A	2	HOSE BRACKET(LARGE ENCOR E)	
58	962957	4	SCR 10-16X 1/2 PN*ST HI	
59	962798	1	SCR 10-24X 1/2 PN*SS	L SERIES
60	920296	1	10-24 ELASTIC STOP NUT	L SERIES
62	77194B	1	LABELCONTROLMOTORTRAVERSE	
64	83010A	1	1/8 RIVET	
65	41801A	1	CONTACTOR 36V	
67	920722	1	NUT.10-32 ELASTIC STOP ZN	
68	912287	1	RECTIFIER-FWB.	