



*pulito personalizzato
customized cleaning*



KLINIKline
FIMAP

PROFYline
FIMAP

INDYline
FIMAP

BASICline
FIMAP

Magna 65-70-75-83

01/2006

*CATALOGO RICAMBI
SPARE PARTS CATALOGUE
CATALOGUE DES PIECES DE RECHANGE
ERSATZTEILKATALOG
CATALOGO PIEZAS DE REPUESTO*

- I** Le descrizioni contenute nella presente pubblicazione non si intendono impegnative. La Ditta pertanto, si riserva il diritto di apportare, in qualunque momento, le eventuali modifiche ad organi, dettagli, forniture di accessori, che essa ritiene convenienti per un miglioramento o per qualsiasi esigenza di carattere costruttivo o commerciale.
La riproduzione anche parziale dei testi e dei disegni, contenuti nel presente catalogo, è vietata ai sensi di legge.
- GB** The descriptions and illustrations contained in the present publication are understood to be non-binding. The Manufacturer thus reserves the rights to effect, at any time, any such alterations to items, component parts and accessory supplies as it may deem necessary for the purposes of improvement or in order to meet any demand of constructional or commercial nature.
Reproduction of either text or drawings, in full or in part, other than with the prior written consent of Comac, is expressly forbidden.
- F** Les descriptions et les illustrations contenues dans la présente publication n'engagent pas le constructeur. Le Fabricant se réserve le droit de modifier à tout moment les organes, détails et fournitures d'accessoires nécessaires à une amélioration technique ou commerciale des machines.
La reproduction même partielle des textes et illustrations contenus dans ce catalogue est illégale, tout contrairement elle pourra être pénalement poursuivie.
- D** Die in dieser Anleitung enthaltenen Beschreibungen und Abbildungen sind unverbindlich. Die Firma behält sich das Recht vor, eventuelle Änderungen an Elementen, Einzelteilen und Lieferungen von Zubehörteilen ohne Ankündigung vorzunehmen, welche sich im Hinblick auf konstruktive Verbesserungen ergeben.
Der Nachdruck der Texte und Zeichnungen, die in diesem Katalog enthalten sind, auch teilweise, ist laut Gesetz untersagt.
- E** Las descripciones contenidas en esa publicación no son vinculantes. Por consiguiente la Empresa se reserva el derecho de modificar eventualmente en cualquier momento las piezas, los detalles y los suministros de piezas de repuesto, de la manera que considera útil para lograr mejoras o por cualquier exigencia de tipo constructivo o comercial.
La reproducción aún parcial de los textos y de los dibujos contenidos en este catálogo queda prohibida con arreglo a la ley.

I **INTRODUZIONE**

Il presente vuole essere da guida per l'ordinazione delle parti di ricambio ed è stato realizzato in modo da consentire una rapida identificazione della macchina in tutte le sue versioni e quindi una rapida visualizzazione dei pezzi che la compongono.

MODALITA' DI ORDINAZIONE

Per facilitare la ricerca di magazzino e la spedizione dei pezzi di ricambio, si pregano vivamente i Sigg. Clienti di attenersi alle seguenti norme e specificare sempre :

- a) modello e numero di matricola della macchina;
- b) numero di posizione e numero di tavola dove sono rappresentati;
- c) codice di ordinazione e denominazione;
- d) quantità dei pezzi desiderati;
- e) indirizzo esatto e ragione sociale del Committente, completo con l'eventuale recapito per la consegna della merce;
- f) mezzo di spedizione desiderato. (Nel caso questa voce non sia specificata la Ditta Costruttrice si riserva di usare a sua discrezione il mezzo più opportuno).

GB **INTRODUCTION**

This catalogue is intended to serve as a guide for the ordering of spare parts and is designed to facilitate rapid identification of the machine in all its versions and rapid location of its component parts.

HOW TO ORDER

For the purpose of simplifying stock searching and delivery of spare parts, we would ask our customers to observe the following standard procedures, at all times specifying:

- a) the model and part number of the machine;
- b) the position number and the number of the table of chart in which the parts appear;
- c) ordering code and part name;
- d) quantity of parts required;
- e) precise address and company status of the purchaser placing the order, complete with address for delivery of the goods;
- f) shipping means required.

F **INTRODUCTION**

Le présent catalogue a pour but de guider l'utilisateur dans les commandes de pièces détachées. Il a été réalisé pour faciliter une identification rapide de la machine dans toutes ses versions et permet ainsi un repérage rapide de ses composants.

COMMENT PASSER COMMANDE

A fin de simplifier la recherche dans le magasin et l'expédition des pièces de rechange, nous prions notre clientèle de respecter la procédure suivante en indiquant toujours:

- a) le modèle et le numéro de la machine;
- b) le numéro de la position et numéro du tableau sur lequel figure la pièce;
- c) la référence et la dénomination;
- d) la quantité des pièces demandées;
- e) l'adresse exacte et la raison sociale de l'acheteur qui passe la commande, en indiquant l'adresse de livraison;
- f) le moyen de transport désiré (dans le cas où ceci n'est pas précisé l'expéditeur se réserve le droit de choisir le transporteur).

D **EINLEITUNG**

Der vorliegende Katalog versteht sich als Führer für Ersatzteile und soll eine rasche Identifikation der Maschine in all ihren Ausführungen ermöglichen und daher ein sofortiges Erkennen der Teile, aus denen sie besteht.

BESTELLVORSCHLAG

Um ein Auffinden im Lager und den Versand der Ersatzteile zu erleichtern, werden die Kunden ersucht, sich an folgende Normen zu halten und immer folgendes anzugeben:

- a) Modell- und Gerätenummer;
- b) Positions- und Tafelnummer, wo sie dargestellt sind;
- c) Bestellnummer und Handelsbezeichnung;
- d) Menge der gewünschten Teile;
- e) Genaue Adresse und Firmennamen des Auftraggebers, gemeinsam der ev. Anschrift für die Zusendung der Ware;
- f) Die gewünschte Versandart (falls nicht angegeben, behält sich der Lieferant das Recht vor, die günstigste Art zu wählen).

E **INTRODUCCIÓN**

Ese catálogo quiere servir como guía para pedir las piezas de repuesto y se ha realizado de manera de consentir una rápida identificación de la máquina en todas sus versiones y por consiguiente una rápida individuación de las piezas que la componen.

MODALIDADES DE LOS PEDIDOS

Para la búsqueda en el almacén y el envío de las piezas de repuesto, se ruega encarecidamente a los Sres. Clientes de seguir las reglas siguientes y de especificar siempre:

- a) el modelo y el número de matricula de la máquina;
- b) el número de posición y el número de la tabla donde son representadas;
- c) el código de pedido y la denominación;
- d) el número de piezas que se desean;
- e) las señas exactas y la razón social del Comitent, indicando también las señas eventuales para la entrega de la mercancía;
- f) El medio de envío que se desea. (En caso de que ese dato no se haya especificado, la Empresa Constructora se reserva el derecho de utilizar a su elección el medio más adecuado).

GRUPPO BASAMENTO LAVANTE M65/75/83

BRUSHES BASE ASSY WITH SCRUBBING SYSTEM M65/75/83

GROUPE PLATEAU DES BROSSES AVEC SYSTEME DE BROSSES ROTATIVES M65/75/83

GRUPPE BUERSTENGESTELL MIT TELLERBUERSTENVORRICHTUNG M65/75/83

GRUPO BANCADA CEPILLOS CON SISTEMA CEPILLOS GIRATORIOS M65/75/83

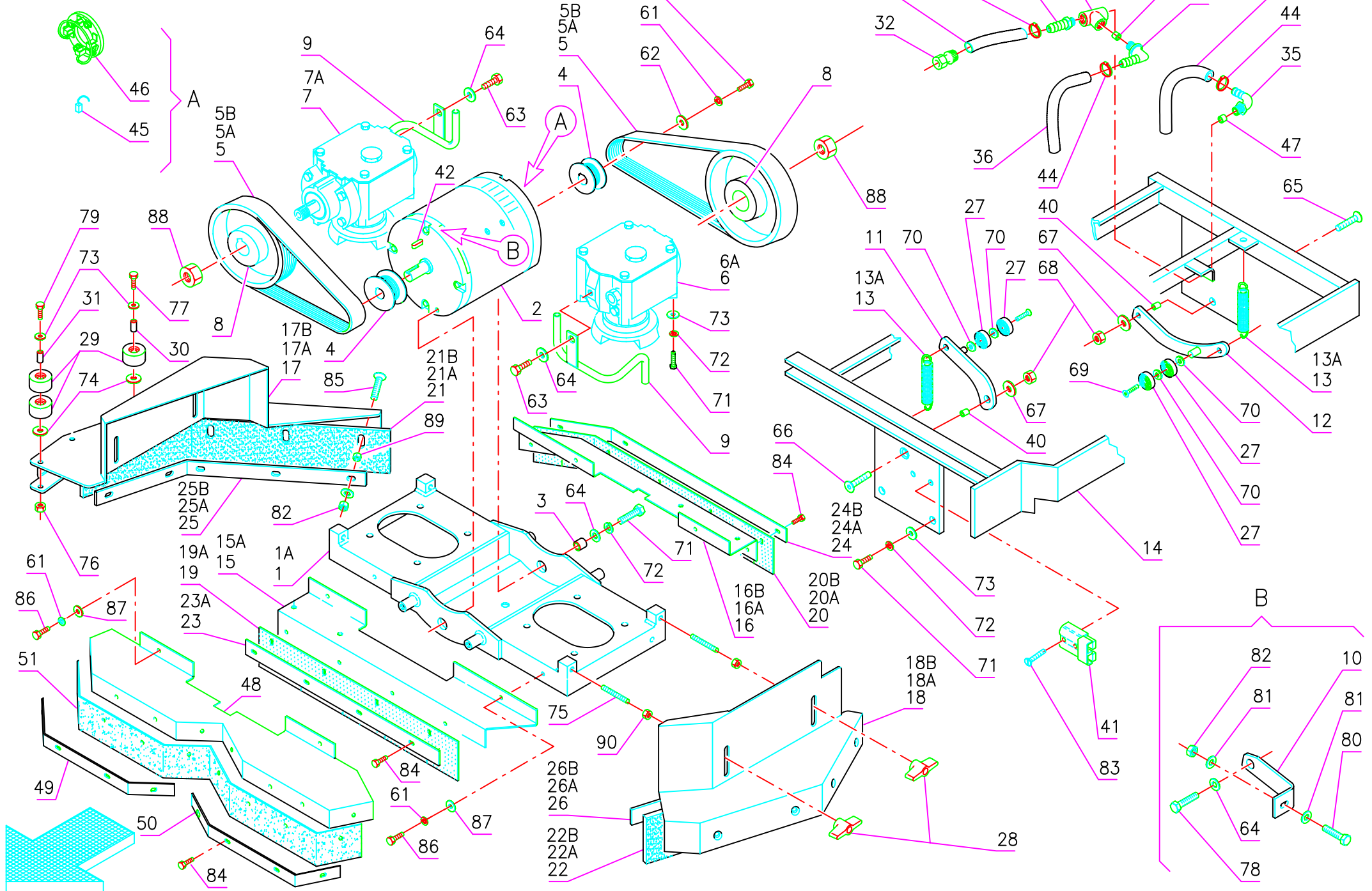

Pos.	Mod.	Codice	Q.tà	Denominazione	Denomination	Description	Benennung	Descripcion
1	65	E9828010	1	BASAMENTO SPAZZOLE	BRUSHES BASE	EMBASE DES BROSSES	BÜRSTENGESTELL	BANCADA CEPILLOS
1A	75/83	E9839010	1	BASAMENTO SPAZZOLE	BRUSHES BASE	EMBASE DES BROSSES	BÜRSTENGESTELL	BANCADA CEPILLOS
2		E8230360	1	MOTORE 36V 900W	MOTOR	MOTEUR	MOTOR	MOTOR
3		E9105060	2	BOCCOLA	BUSHING	BAGUE	BUCHSE	CASQUILLO
4		E9420180	2	PULEGGIA MOTORE	MOTOR PULLEY	POULIE DE MOTEUR	RIEMENSCHLEIBE MOTOR	POLEA DE MOTOR
5	65	T0130009	2	CINGHIA POLY V58 L=584	BELT	COURROIE	RIEMEN	CORREA
5A	75	T0130007	2	CINGHIA POLY V58 L=610	BELT	COURROIE	RIEMEN	CORREA
5B	83	T0130010	2	CINGHIA POLY V58 L=660	BELT	COURROIE	RIEMEN	CORREA
6		M0140020	1	RIDUTTORE SX COMPLETO	REDUCTION GEAR ASSEMBLY SX	REDUCTEUR COMPLET SX	GETRIEBE KOMPLETT SX	REDUCTOR COMPLETO SX
6A	KLINIK	M2050001	1	RIDUTTORE SX COMPLETO	REDUCTION GEAR ASSEMBLY SX	REDUCTEUR COMPLET SX	GETRIEBE KOMPLETT SX	REDUCTOR COMPLETO SX
7		M0140010	1	RIDUTTORE DX COMPLETO	REDUCTION GEAR ASSEMBLY DX	REDUCTEUR COMPLET DX	GETRIEBE KOMPLETT DX	REDUCTOR COMPLETO DX
7A	KLINIK	M2050001	1	RIDUTTORE DX COMPLETO	REDUCTION GEAR ASSEMBLY DX	REDUCTEUR COMPLET DX	GETRIEBE KOMPLETT DX	REDUCTOR COMPLETO DX
8		E9420170	2	PULEGGIA CONDOTTA	PULLEY	POULIE	RIEMENSCHLEIBE	POLEA
9		R2801010	2	TUBO	PIPE	TUBE	ROHR	TUBO
10		R2801120	1	STAFFA	SUPPORT	ATTAQUE	HALTERUNG	SOPORTE FIJADOR
11		R2801090	1	SUPP. TENDICINGHIA ANT.	SUPPORT	SUPPORT	HALTERUNG	SOPORTE
12		R2801100	1	SUPP. TENDICINGHIA POST.	SUPPORT	SUPPORT	HALTERUNG	SOPORTE
13	65	E9220050	2	MOLLA	SPRING	RESSORT	FEDER	RESORTE
13A	75	E9220120	2	MOLLA	SPRING	RESSORT	FEDER	RESORTE
14		R2802020	1	ATTACCO BASAMENTO	COUPLING	ATTAQUE	KUPPLUNG	ACOPLAMIENTO
15	65	R2801150	1	SUPPORTO ANTERIORE	SUPPORT	SUPPORT	HALTERUNG	SOPORTE
15A	75	R3001070	1	SUPPORTO ANTERIORE	SUPPORT	SUPPORT	HALTERUNG	SOPORTE
16	65	R2801070	1	SUPPORTO POSTERIORE	SUPPORT	SUPPORT	HALTERUNG	SOPORTE
16A	75	R3001030	1	SUPPORTO POSTERIORE	SUPPORT	SUPPORT	HALTERUNG	SOPORTE
16B	83	R3901030	1	SUPPORTO POSTERIORE	SUPPORT	SUPPORT	HALTERUNG	SOPORTE
17	65	R2801130	1	SUPPORTO DX	SUPPORT	SUPPORT	HALTERUNG	SOPORTE
17A	75	R3001050	1	SUPPORTO DX	SUPPORT	SUPPORT	HALTERUNG	SOPORTE
17B	83	R3901020	1	SUPPORTO DX	SUPPORT	SUPPORT	HALTERUNG	SOPORTE
18	65	R2801140	1	SUPPORTO SX	SUPPORT	SUPPORT	HALTERUNG	SOPORTE
18A	75	R3001060	1	SUPPORTO SX	SUPPORT	SUPPORT	HALTERUNG	SOPORTE
18B	83	R3901040	1	SUPPORTO SX	SUPPORT	SUPPORT	HALTERUNG	SOPORTE
19	65	E7628070	1	PARASPRUZZI ANTERIORE	SPLASH GUARD	BAVETTE	SPRITZGUMMI	PARASALPICADURAS
19A	75	E7630070	1	PARASPRUZZI ANTERIORE	SPLASH GUARD	BAVETTE	SPRITZGUMMI	PARASALPICADURAS
20	65	E7628030	1	PARASPRUZZI POSTERIORE	SPLASH GUARD	BAVETTE	SPRITZGUMMI	PARASALPICADURAS
20A	75	E7630030	1	PARASPRUZZI POSTERIORE	SPLASH GUARD	BAVETTE	SPRITZGUMMI	PARASALPICADURAS
20B	83	E7639030	1	PARASPRUZZI POSTERIORE	SPLASH GUARD	BAVETTE	SPRITZGUMMI	PARASALPICADURAS
21	65	E7628050	1	PARASPRUZZI DX	SPLASH GUARD	BAVETTE	SPRITZGUMMI	PARASALPICADURAS
21A	75	E7630050	1	PARASPRUZZI DX	SPLASH GUARD	BAVETTE	SPRITZGUMMI	PARASALPICADURAS
21B	83	E7639020	1	PARASPRUZZI DX	SPLASH GUARD	BAVETTE	SPRITZGUMMI	PARASALPICADURAS
22	65	E7628060	1	PARASPRUZZI SX	SPLASH GUARD	BAVETTE	SPRITZGUMMI	PARASALPICADURAS
22A	75	E7630060	1	PARASPRUZZI SX	SPLASH GUARD	BAVETTE	SPRITZGUMMI	PARASALPICADURAS
22B	83	E7639040	1	PARASPRUZZI SX	SPLASH GUARD	BAVETTE	SPRITZGUMMI	PARASALPICADURAS
23	65	E8828070	1	LAMA PARASPRUZZI ANT.	BLADE	PLAQUETTE	LEISTE	LISTON
23A	75	E8830070	1	LAMA PARASPRUZZI ANT.	BLADE	PLAQUETTE	LEISTE	LISTON
24	65	E8828030	1	LAMA PARASPRUZZI POST.	BLADE	PLAQUETTE	LEISTE	LISTON
24A	75	E8830030	1	LAMA PARASPRUZZI POST.	BLADE	PLAQUETTE	LEISTE	LISTON
24B	83	E8839040	1	LAMA PARASPRUZZI POST.	BLADE	PLAQUETTE	LEISTE	LISTON
25	65	E8828050	1	LAMA PARASPRUZZI DX	BLADE	PLAQUETTE	LEISTE	LISTON
25A	75	E8830050	1	LAMA PARASPRUZZI DX	BLADE	PLAQUETTE	LEISTE	LISTON
25B	83	E8839030	1	LAMA PARASPRUZZI DX	BLADE	PLAQUETTE	LEISTE	LISTON

Pos.	Mod.	Codice	Q.tà	Denominazione	Denomination	Description	Benennung	Descripcion
26	65	E8828060	1	LAMA PARASPRUZZI SX	BLADE	PLAQUETTE	LEISTE	LISTON
26A	75	E8830060	1	LAMA PARASPRUZZI SX	BLADE	PLAQUETTE	LEISTE	LISTON
26B	83	E8839050	1	LAMA PARASPRUZZI SX	BLADE	PLAQUETTE	LEISTE	LISTON
27		T0511502	4	CUSCINETTO 6202-2RS1	BEARING	ROULEMENT	LAGER	COJINETE
28		T4008006	4	GALLETTO M8	WING NUT	PAPILLON	FLUGELSCHRAUBE	POMO
29		E7020050	4	RUOTA PARACOLPI	WHEEL	ROUE	RAD	RUEDA
30		E9103060	2	BOCCOLA	BUSHING	BAGUE	BUCHSE	CASQUILLO
31		E9100410	1	BOCCOLA	BUSHING	BAGUE	BUCHSE	CASQUILLO
32		T4540002	1	RACCORDO RAPIDO	FITTING	RACCORD	VERSCHRAUBUNG	RACOR T
33		T4530002	1	RACCORDO A "T" ½ F	FITTING	RACCORD	VERSCHRAUBUNG	RACOR T
34		T4540028	1	PORTAGOMMA 1/2x16	CONNECTOR	RACCORD	SCHLAUCHANSCHLUSS	EMPALME TUBO DE GOMA
35		T4520011	2	PORTAGOMMA 1/2x13	CONNECTOR	RACCORD	SCHLAUCHANSCHLUSS	EMPALME TUBO DE GOMA
36		E7521300	1	TUBO Ø10x230	HOSE	TUYAU	SCHLAUCH	TUBO
37		E7521090	1	TUBO Ø10x350	HOSE	TUYAU	SCHLAUCH	TUBO
38		E7510510	1	TUBO Ø14x550	HOSE	TUYAU	SCHLAUCH	TUBO
40		E9105030	2	BOCCOLA	BUSHING	BAGUE	BUCHSE	CASQUILLO
41		T2700001	1	CONNETTORE	CONNECTOR	CONNECTEUR	LADESTECKER	CONECTADOR
42		T0405051	2	LINGUETTA 5x5x20	TONGUE	LANGUETTE	PASSFEDER	TONGUE
43		T4220006	1	FASCETTA A VITE	CLAMP	COLLIER	LAGGERING	ANILLO
44		T4210001	2	FASCETTA PVC	CLAMP	COLLIER	LAGGERING	ANILLO
45		T1710181	-	SPAZZOLE MOTORE	BRUSH	BROSSE	BURSTE	CEPILLO
46		T1700020	-	SUPPORTO SPAZZ. COMPLETO	SUPPORT	SUPPORT	LAGER	SOPORTE
47		E9000280	2	DISTANZIALE DI STROZZATURA	SPACER	ENTRETOISE	DISTANZHÜLSE	DISTANCIADOR
48	83	R3901010	1	SUPPORTO ANTERIORE	SUPPORT	SUPPORT	HALTERUNG	SOPORTE
49	83	E8839020	1	LAMA PARASPRUZZI ANT. DX	BLADE	PLAQUETTE	LEISTE	LISTON
50	83	E8839010	1	LAMA PARASPRUZZI ANT. SX	BLADE	PLAQUETTE	LEISTE	LISTON
51	83	E7639010	1	PARASPRUZZI ANTERIORE	SPLASH GUARD	BAVETTE	SPRITZGUMMI	PARASALPICADURAS
60				VITE M6x16 TE UNI 5739	SCREW	VIS	SCHRAUBE	TORNILLO
61				RONDELLA Ø 6 GROWER	WASHER	RONDELLE	UNTERLAGSCHEIBE	ARANDELA
62				RONDELLA Ø 6x24 UNI 6593	WASHER	RONDELLE	UNTERLAGSCHEIBE	ARANDELA
63				VITE M10x12 TE UNI 5739	SCREW	VIS	SCHRAUBE	TORNILLO
64				RONDELLA Ø 10x21 UNI 6592	WASHER	RONDELLE	UNTERLAGSCHEIBE	ARANDELA
65				VITE M10x35 TE UNI 5739	SCREW	VIS	SCHRAUBE	TORNILLO
66				VITE M10x35 TPSEI UNI 5933	SCREW	VIS	SCHRAUBE	TORNILLO
67				RONDELLA Ø 10x30 UNI 6593	WASHER	RONDELLE	UNTERLAGSCHEIBE	ARANDELA
68				DADO M10 AUTOBL. UNI 7474	LOCK NUT	ECROU AUTOBLOQUANT	STOPMUTTER	TUERCA AUTOBLOCANTE
69				VITE M8x16 TPSEI UNI 5933	SCREW	VIS	SCHRAUBE	TORNILLO
70				RONDELLA Ø 15 OTTONE	WASHER	RONDELLE	UNTERLAGSCHEIBE	ARANDELA
71				VITE M8x25 TE UNI 5739	SCREW	VIS	SCHRAUBE	TORNILLO
72				RONDELLA Ø 8 GROWER	WASHER	RONDELLE	UNTERLAGSCHEIBE	ARANDELA
73				RONDELLA Ø 8x17 UNI 6592	WASHER	RONDELLE	UNTERLAGSCHEIBE	ARANDELA
74				RONDELLA Ø 8x24 UNI 6593	WASHER	RONDELLE	UNTERLAGSCHEIBE	ARANDELA
75				GRANO M8x40 UNI 5929	DOWEL	VIS	MADENSCHRAUBE	TORNILLO
76				DADO M8 AUTOBL. UNI 7474	LOCK NUT	ECROU AUTOBLOQUANT	STOPMUTTER	TUERCA AUTOBLOCANTE
77				VITE M8x30 TE UNI 5739	SCREW	VIS	SCHRAUBE	TORNILLO
78				VITE M10x20 TE UNI 5739	SCREW	VIS	SCHRAUBE	TORNILLO
79				VITE M8x70 TE UNI 5739	SCREW	VIS	SCHRAUBE	TORNILLO
80				VITE M6x20 TE UNI 5739	SCREW	VIS	SCHRAUBE	TORNILLO
81				RONDELLA Ø 6x12 UNI 6592	WASHER	RONDELLE	UNTERLAGSCHEIBE	ARANDELA
82				DADO M6 AUTOBL. UNI 7474	LOCK NUT	ECROU AUTOBLOQUANT	STOPMUTTER	TUERCA AUTOBLOCANTE

TAV.01 rev.04 GRUPPO BASAMENTO LAVANTE M65/75/83

Pos.	Mod.	Codice	Q.tà	Denominazione	Denomination	Description	Benennung	Descripcion
83				VITE M3x16 TC UNI 6107	SCREW	VIS	SCHRAUBE	TORNILLO
84				VITE M5x16 TC UNI 6107	SCREW	VIS	SCHRAUBE	TORNILLO
85				VITE M6x25 TPSEI UNI 5933	SCREW	VIS	SCHRAUBE	TORNILLO
86				VITE M6x10 TE UNI 5739	SCREW	VIS	SCHRAUBE	TORNILLO
87				RONDELLA Ø 6x18 UNI 6593	WASHER	RONDELLE	UNTERLAGSCHEIBE	ARANDELA
88				DADO M16x1,5 UNI 7474	LOCK NUT	ECROU AUTOBLOQUANT	STOPMUTTER	TUERCA AUTOBLOCANTE
89				DADO M6 UNI 5588	NUT	ECROU	MUTTER	TUERCA
90				DADO M8 UNI 5588	NUT	ECROU	MUTTER	TUERCA

GRUPPO BASAMENTO SPAZZANTE M70
 BRUSHES BASE ASSY WITH SWEEPING SYSTEM M70
 GROUPE PLATEAU DES BROSSES AVEC SYSTEME BALAYEUSE M70
 GRUPPE BUERTENGESTELL MIT WALZENANVORRICHTUNG M70
 GRUPO BANCADA CEPILLOS CON SISTEMA CEPILLOS CILINDRICOS M70

●	→	05 2904 5731
●●	→	05 2907 5886

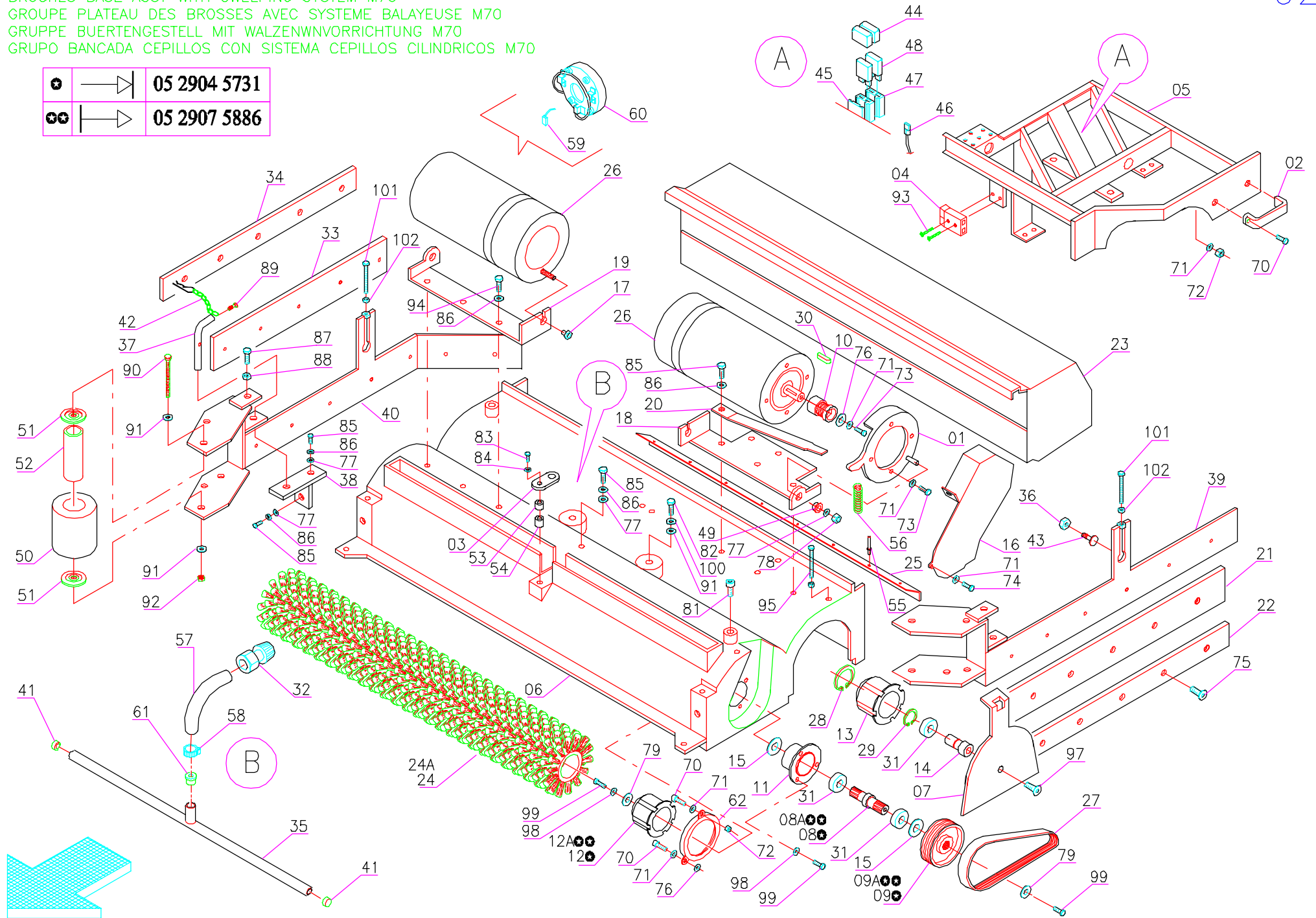

Pos.	Mod.	Codice	Q.tà	Denominazione	Denomination	Description	Benennung	Descripcion
1		R2901010	2	PIASTRA	PLATE	PLAQUE	TELLER	PLACA
2		T4100014	1	MANIGLIA	HANDLE	MANCHE	HANDGRIFF	MANILLA
3		R2901020	1	PIASTRINA	PLAQUE	PLAQUETTE	BEFESTIGUNGSAUFLAGE	PLAQUETA
4		T2700001	1	CONNETTORE	CONNECTOR	CONNECTEUR	LADESTECKER	CONECTADOR
5	PROFY	R2902010	1	ATTACCO BASAMENTO	COUPLING	ATTAQUE	KUPPLUNG	ACOPLAMIENTO
6		R2901030	1	TUNNEL	TUNNEL	CARTER BALAI	TUNNEL	TUNEL
7		R2901040	2	PIASTRA	PLATE	PLAQUE	TELLER	PLACA
8		R2901050	2	ALBERO	SHAFT	ARBRE	LENKWELLE	EJE
08A		40707380	2	ALBERO	SHAFT	ARBRE	LENKWELLE	EJE
9		E9410280	2	PULEGGIA CONDOTTA	PULLEY	POULIE	RIEMENSCHLEIBE	POLEA
09A		69410390	2	PULEGGIA CONDOTTA	PULLEY	POULIE	RIEMENSCHLEIBE	POLEA
10		E9410290	2	PULEGGIA MOTRICE	MOTOR PULLEY	POULIE DE MOTEUR	RIEMENSCHLEIBE MOTOR	POLEA DE MOTOR
11		R2901060	2	SUPPORTO	SUPPORT	SUPPORT	HALTERUNG	SOPORTE
12		R2901070	2	MOZZO	HUB	MOYEU	NABE	CUBO
12A		40707390	2	MOZZO	HUB	MOYEU	NABE	CUBO
13		R2901080	2	MOZZO FOLLE	HUB	MOYEU	NABE	CUBO
14		R2901090	2	PERNO	PIN	AXE	BOLZEN	PERNO
15		R2901100	4	DISTANZIALE	SPACER	ENTRETOISE	DISTANZHÜLSE	DISTANCIADOR
16		R2901130	2	CARTER	COVER	CARTER	ABDECKUNG	CARTER
17		E9100390	2	BOCCOLA	BUSHING	BAGUE	BUCHSE	CASQUILLO
18		R2901150	1	SUPPORTO MOTORE SN	SUPPORT	SUPPORT	HALTERUNG	SOPORTE
19		R2901160	1	SUPPORTO MOTORE DX	SUPPORT	SUPPORT	HALTERUNG	SOPORTE
20		R2901170	2	MOLLA	SPRING	RESSORT	FEDER	RESORTE
21		E7629010	1	PARASPRUZZI SX 33 SHORE	SPLASH GUARD	BAVETTE	SPRITZGUMMI	PARASALPICADURAS
22		E8829010	1	LAMA PARASPRUZZI SX	BLADE	PLAQUETTE	LEISTE	LISTON
23		R2901200	1	CASSETTO	DRAWER	TIROIR	SCHUBLADE	CAJON
24		E6829010	2	SPAZZOLA PPL 0,8	BRUSH	BROSSE	BÜRSTE	CEPILLO
24A	INDY	E6829020	2	SPAZZOLA TYNEX	BRUSH	BROSSE	BÜRSTE	CEPILLO
25		R2901210	1	LAMA	BLADE	PLAQUETTE	LEISTE	LISTON
26		E8230340	2	MOTORE 36V 650W 2000G	MOTOR	MOTEUR	MOTOR	MOTOR
27		T0130008	2	CINGHIA POLY V J8 L.457	BELT	COURROIE	RIEMEN	CORREA
28		T0210002	2	SEEGER I 35	SEEGER RING	SERRE CLIPS	SEEGERRING	ANILLO SEEGER
29		T0220001	2	SEEGER E 15	SEEGER RING	SERRE CLIPS	SEEGERRING	ANILLO SEEGER
30		T0405051	2	CHIAVETTA 5x5x20 UNI 6604/69	KEY	CLAVETTE	KEIL	CLAVIJA
31		T0511502	6	CUSCINETTO 6202-2RS	BEARING	ROULEMENT	LAGER	COJINETE
32		T4540002	1	RACCORDO RAPIDO	FITTING	RACCORD	VERSCHRAUBUNG	RACOR
33		E7629020	1	PARASPRUZZI DX 33 SHORE	SPLASH GUARD	BAVETTE	SPRITZGUMMI	PARASALPICADURAS
34		E8829020	1	LAMA PARASPRUZZI DX	BLADE	PLAQUETTE	LEISTE	LISTON
35		R2901220	1	TUBO DISTRIBUTORE	TUBE	TUYAU	ROHR	TUBO
36		R2901230	2	DISTANZIALE	SPACER	ENTRETOISE	DISTANZHÜLSE	DISTANCIADOR
37		R2901240	2	SPINA	SPRING PIN	FOURCHETTE	SPANNSTIFT	PASADOR
38		R2901250	2	ATTACCO	COUPLING	ATTAQUE	KUPPLUNG	ACOPLAMIENTO
39		R2901260	1	SUPPORTO PARASPRUZZI SX	SUPPORT	SUPPORT	HALTERUNG	SOPORTE
40		R2901270	1	SUPPORTO PARASPRUZZI DX	SUPPORT	SUPPORT	HALTERUNG	SOPORTE
41		T4803015	2	TAPPO	PLUG	BOUCHON	DECKEL	TAPON
42		R2901280	2	CATENELLA	CHAIN	CHAINE	KETTE	CADENA
43		T0900605	2	VITE M6X30 TTDE	SCREW	VIS	SCHRAUBE	TORNILLO
44		T2400023	2	COPERCHIO FUSIBILI	COVER	COUVERCLE	DECKEL	TAPA
45		T2400015	1	PIASTRINA	SUPPORT PLATE	PLAQUETTE	STÜTZPLATTE	OREJA DE APOYO
46		T2400012	4	TERMINALE CON CLIPS	TERMINAL	BORNE	KLEMMME	TERMINAL

Pos.	Mod.	Codice	Q.tà	Denominazione	Denomination	Description	Benennung	Descripcion
47		T2400002	2	PORTAMAXIFUSIBILE	FUSEHOLDER	PORTE-FUSIBLE	SICHERUNGSHALTER	PORTAFUSIBILE
48		T2404001	2	FUSIBILE 40A	FUSE	FUSIBLE	SICHERUNG	FUSIBILE
49		E9115010	2	BOCCOLA	BUSHING	BAGUE	BUCHSE	CASQUILLO
50		E7020110	4	RUOTA PARACOLPI	WHEEL	ROUE	RAD	RUEDA
51		R1511080	8	RONDELLA SPECIALE	SPECIAL WASHER	RONDELLE SPECIAL	BESONDERESCHEIBE	ARANDELA ESPECIAL
52		R1511090	4	TUBO	PIPE	TUBE	ROHR	TUBO
53		E9002040	1	DISTANZIALE PVC H=5	SPACER	ENTRETOISE	DISTANZHÜLSE	DISTANCIADOR
54		E9003010	1	DISTANZIALE PVC H=7,5	SPACER	ENTRETOISE	DISTANZHÜLSE	DISTANCIADOR
55		T1400003	9	RIVETTO Ø 4,8x14 ALLUMINIO	RIVET	RIVET	NIET	REMACHE
56		E9210020	2	MOLLA	SPRING	RESSORT	FEDER	RESORTE
57		E7510560	1	TUBO Ø 14x650	HOSE	TUYAU	SCHLAUCH	TUBO DE GOMA
58		T4220006	1	FASCETTA	CLAMP	COLLIER	BRIDE	ABRAZADERA
59		T1707141		SPAZZOLA MOTORE	CARBON BRUSH MOTOR	CHARBON MOTEUR	KOHLEBÜRSTE	ESCOBILLA MOTOR
60		T1700018		CALOTTA SPAZZOLE COMPLETA	CARBON BRUSH HOLDER	PORTE-CHARBON	KOHLEBÜRSTENHALTERUNG	PORTAESCOBILLAS
61		E9100420	1	BOCCOLA	BUSHING	BAGUE	BUCHSE	CASQUILLO
62		R1507080	2	ANELLO TAGLIAFILO	RING	ANNEAU	RING	ANILLO
70				VITE M6x20 TCEI UNI 5931	SCREW	VIS	SCHRAUBE	TORNILLO
71				RONDELLA Ø 6 GROWER	LOCK WASHER	RONDELLE FREIN	ZAHNSCHEIBE	ARANDELA DENTADA
72				DADO M6 AUTOBL. UNI 7474	LOCK NUT	ECROU AUTOBLOQUANT	STOPMUTTER	TUERCA AUTOBLOCANTE
73				VITE M6x16 TE UNI 5739	SCREW	VIS	SCHRAUBE	TORNILLO
74				VITE M6x10 TE UNI 5739 INOX	SCREW	VIS	SCHRAUBE	TORNILLO
75				VITE M5x16 TPSEI UNI 5933	SCREW	VIS	SCHRAUBE	TORNILLO
76				RONDELLA Ø 6x18UNI 6593	WASHER	RONDELLE	UNTERLAGSCHEIBE	ARANDELA
77				RONDELLA Ø 8x17 UNI 6592	WASHER	RONDELLE	UNTERLAGSCHEIBE	ARANDELA
78				DADO M8 AUTOBL. UNI 7474	LOCK NUT	ECROU AUTOBLOQUANT	STOPMUTTER	TUERCA AUTOBLOCANTE
79				RONDELLA Ø 6x24 UNI 6593	WASHER	RONDELLE	UNTERLAGSCHEIBE	ARANDELA
81				VITE M8x18 TCEI UNI 5931	SCREW	VIS	SCHRAUBE	TORNILLO
82				VITE M10x30 TE UNI 5739	SCREW	VIS	SCHRAUBE	TORNILLO
83				VITE M5x25 TE UNI 5739 INOX	SCREW	VIS	SHRAUBE	TORNILLO
84				RONDELLA Ø 5 DENT.	LOCK WASHER	RONDELLE FREIN	ZAHNSCHEIBE	ARANDELA DENTADA
85				VITE M8X20 TE UNI 5739	SCREW	VIS	SCHRAUBE	TORNILLO
86				RONDELLA Ø 8 GROWER	LOCK WASHER	RONDELLE FREIN	ZAHNSCHEIBE	ARANDELA DENTADA
87				VITE M8x30 TE UNI 5739 INOX	SCREW	VIS	SCHRAUBE	TORNILLO
88				DADO M8 INOX UNI 5589	NUT	ECROU	MUTTER	TUERCA
89				VITE M4x10 TC UNI 6107 INOX	SCREW	VIS	SCHRAUBE	TORNILLO
90				VITE M10x120 TE UNI 5737	SCREW	VIS	SCHRAUBE	TORNILLO
91				RONDELLA 10x21 UNI 6592	WASHER	RONDELLE	UNTERLAGSCHEIBE	ARANDELA
92				DADO M10 AUTOBL. UNI 7474	LOCK NUT	ECROU AUTOBLOQUANT	STOPMUTTER	TUERCA AUTOBLOCANTE
93				VITE M3X16 TCTC UNI 7687	SCREW	VIS	SCHRAUBE	TORNILLO
				ZINC				
94				VITE M8x16 TE UNI 5739	SCREW	VIS	SCHRAUBE	TORNILLO
95				VITE M6x60 TE UNI 5739	SCREW	VIS	SCHRAUBE	TORNILLO
96				DADO M6 UNI 5588	NUT	ECROU	MUTTER	TUERCA
97				VITE M10x16 TPSEI UNI 5933	SCREW	VIS	SCHRAUBE	TORNILLO
98				RONDELLA Ø 6 GROWER	LOCK WASHER	RONDELLE FREIN	ZAHNSCHEIBE	ARANDELA DENTADA
99				VITE M6x12 TE UNI 5739 INOX	SCREW	VIS	SCHRAUBE	TORNILLO
100				RONDELLA Ø 10 GROWER	LOCK WASHER	RONDELLE FREIN	ZAHNSCHEIBE	ARANDELA DENTADA
101				VITE M6x50 TE UNI 5739 A2	SCREW	VIS	SCHRAUBE	TORNILLO
102				DADO M5 UNI 5588 A2	NUT	ECROU	MUTTER	TUERCA

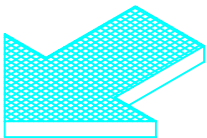
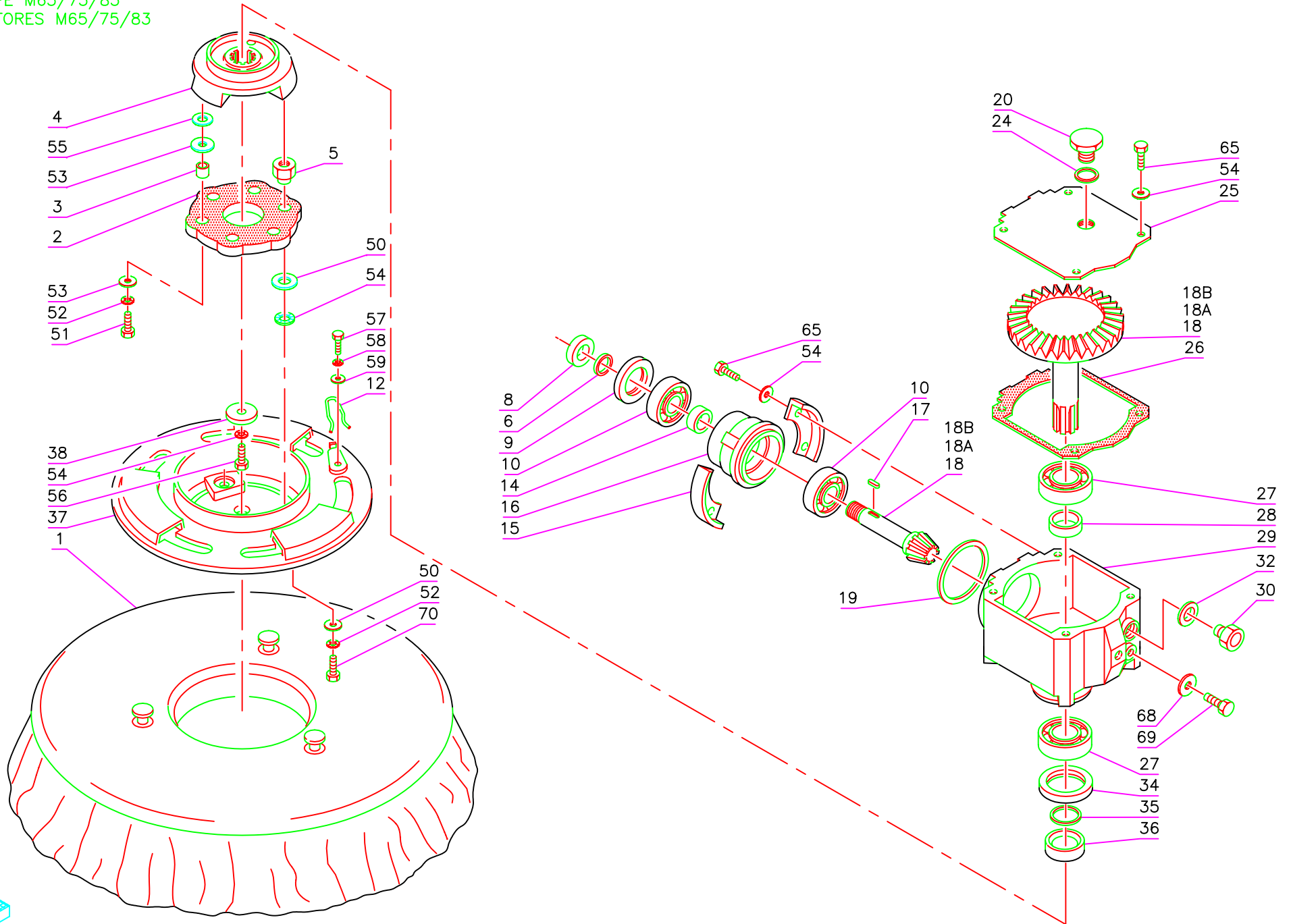

Pos.	Mod.	Codice	Q.tà	Denominazione	Denomination	Description	Benennung	Descripcion
1			2	SPAZZOLA	BRUSH	BROSSE	BÜRSTE	CEPILLO
2		R0101070	2	GIUNTO ELASTICO	FLEXIBLE COUPLING	ENTRAINEMENT ELASTIQUE	GUMMIKUPPLUNG	ACOPLAMIENTO ELASTICO
3		E9001030	6	DISTANZIALE	SPACER	ENTRETOISE	DISTANZHÜLSE	DISTANCIADOR
4	■	R0601060	2	FLANGIA	FLANGE	FLASQUE	FLANSCH	BRIDA
5		E9101040	6	BOCCOLA	BUSHING	BAGUE	BUCHSE	CASQUILLO
6	■	T0800018	2	GUARNIZIONE OR 3068	GASKET	GARNITURE	DICHTUNG	JUNTA
8	■	E9000150	2	DISTANZIALE	SPACER	ENTRETOISE	DISTANZHÜLSE	DISTANCIADOR
9	■	T0730471	2	PARAOILIO Ø30x47x7	OIL SEAL	JOINT PAULSTRA	SIMMERING	ARO RASCADOR DE ACEITE
10	■	T0511704	4	CUSCINETTO 6303	BEARING	ROULEMENT	LAGER	COJINETE
12		E9230060	2	MOLLA BLOCCO SPAZZOLE	SPRING	RESSORT	FEDER	RESORTE
14	■	E9000110	2	DISTANZIALE	SPACER	ENTRETOISE	DISTANZHÜLSE	DISTANCIADOR
15	■	R2705020	4	MORSETTO	HOLDFAST	ETAU	ZWINGE	ABRAZADERA
16	■	R2705050	2	SUPPORTO	SUPPORT	SUPPORT	HALTERUNG	SOPORTE
17	■	T0405053	2	CHIAVETTA 5x5x18	KEY	CLAVETTE	KEIL	CLAVIJA
18	■	E9350040	1	COPPIA CONICA RIDUTTORE SX	BEVEL GEAR PAIR LEFT RED.	PAIR CONIQUE RED. GAUCHE	KEGELRADPAARUNG, LINKS	PAR CONICAS RED. IZQUIERDO
18A	■	E9350030	1	COPPIA CONICA RIDUTTORE DX	BEVEL GEAR PAIR RIGHT RED.	PAIR CONIQUE RED. DROITE	KEGELRADPAARUNG, RECHTS	PAR CONICAS RED. DERECHO
18B	■*	E9350050	2	COPPIA CONICA RIDUTTORE	BEVEL GEAR PAIR RIGHT	PAIR CONIQUE RED.	KEGELRADPAARUNG	PAR CONICAS RED.
19	■	E7400320	2	GUARNIZIONE	GASKET	GARNITURE	DICHTUNG	JUNTA
20	■	T4550015	2	SFIATATOIO	BREATHER	BOUCHON	STÖPSEL	RESPIRADERO
24	■	67400020	2	GUARNIZIONE	GASKET	GARNITURE	DICHTUNG	JUNTA
25	■	R2705030	2	COPERCHIO	COVER	COUVERCLE	DECKEL	TAPA
26	■	E7400330	2	GUARNIZIONE	GASKET	GARNITURE	DICHTUNG	JUNTA
27	■	T0512503	4	CUSCINETTO 6205	BEARING	ROULEMENT	LAGER	COJINETE
28	■	E9000120	2	DISTANZIALE	SPACER	ENTRETOISE	DISTANZHÜLSE	DISTANCIADOR
29	■	R2705040	2	SCATOLA RIDUTTORE	REDUCTION GEAR BOX	BOITIER REDUCTEUR	GETRIEBEGEHÄUSE	CAJA REDUCTOR
30	■	T4806035	2	TAPPO LIVELLO	LEVEL PLUG	BOUCHON DE NIVEAU	STANDSCHRAUBE	TAPON NIVEL
32	■	E7400340	2	GUARNIZIONE	GASKET	GARNITURE	DICHTUNG	JUNTA
34	■	T0738521	2	PARAOILIO Ø38x52x8	OIL SEAL	JOINT PAULSTRA	SIMMERING	ARO RASCADOR DE ACEITE
35	■	T0800017	2	GUARNIZIONE OR 3100	O-RING	JOINT	O-RING	JUNTA ANULAR
36	■	E9000100	2	DISTANZIALE	SPACER	ENTRETOISE	DISTANZHÜLSE	DISTANCIADOR
37		R0601050	2	PIATTO PORTASPAZZOLA	PLATE	PLATEAU	BÜRSTENTRÄGER	PLATO PORTACEPILLO
38		R2705010	2	RONDELLA SPECIALE	SPECIAL WASHER	RONDELLE SPECIALE	UNTERLAGSCHEIBE SPEZIAL	ARANDELA ESPECIAL
50				RONDELLA Ø8x18 CONTACT	WASHER	RONDELLE	UNTERLAGSCHEIBE	ARANDELA
51				VITE M8x30 TE UNI 5739	SCREW	VIS	SCHRAUBE	TORNILLO
52				RONDELLA Ø8 GROWER	LOCK WASHER	RONDELLE FREIN	ZAHNSCHEIBE	ARANDELA DENTADA
53				RONDELLA Ø8x24 UNI 6593	WASHER	RONDELLE	UNTERLAGSCHEIBE	ARANDELA
54				RONDELLA Ø8 SCHNORR	SPLIT WASHER	RONDELLE ELASTIQUE	FEDERRING	ARANDELA
55				RONDELLA Ø 8x17 UNI 6592	WASHER	RONDELLE	UNTERLAGSCHEIBE	ARANDELA
56				VITE M8x18 TCEI UNI 5931-67	SCREW	VIS	SCHRAUBE	TORNILLO
57				VITE M6x10 TE INOX UNI 5739	SCREW	VIS	SCHRAUBE	TORNILLO
58				RONDELLA Ø6 GROWER	WASHER	RONDELLE	UNTERLAGSCHEIBE	ARANDELA
59				RONDELLA Ø6x24 UNI 6593	WASHER	RONDELLE	UNTERLAGSCHEIBE	ARANDELA
64				DADO M16x1.5 AUT. UNI 7474	LOCK NUT	ECROU AUTOBLOQUANT	STOPMUTTER	TUERCA AUTOBLOCANTE
65				VITE M8x20 TE UNI 5739	SCREW	VIS	SCHRAUBE	TORNILLO
68				RONDELLA Ø10x16 ALLUMINIO	WASHER	RONDELLE	UNTERLAGSCHEIBE	ARANDELA
69				VITE M10x12 TE UNI 5739	SCREW	VIS	SCHRAUBE	TORNILLO
70				VITE M8x30 TE UNI 5739	SCREW	VIS	SCHRAUBE	TORNILLO
■		M0140010	1	ASSIEME RIDUTTORE DX (1:4.5)	REDUCTION GEAR ASSY, RIGHT	REDUCTEUR COMPL. DROITE	GETRIEBE KOMPL. RECHTS	GRUPO REDUCTOR DERECHO
■		M0140020	1	ASSIEME RIDUTTORE SX (1:4.5)	REDUCTION GEAR ASSY, LEFT	REDUCTEUR COMPL. GAUCHE	GETRIEBE KOMPL. LINKS	GRUPO REDUCTOR IZQUIERDO
■*	KLINIK	M2050001	2	ASSIEME RIDUTTORE (1:5.8)	REDUCTION GEAR ASSY	REDUCTEUR COMPL.	GETRIEBE KOMPL.	

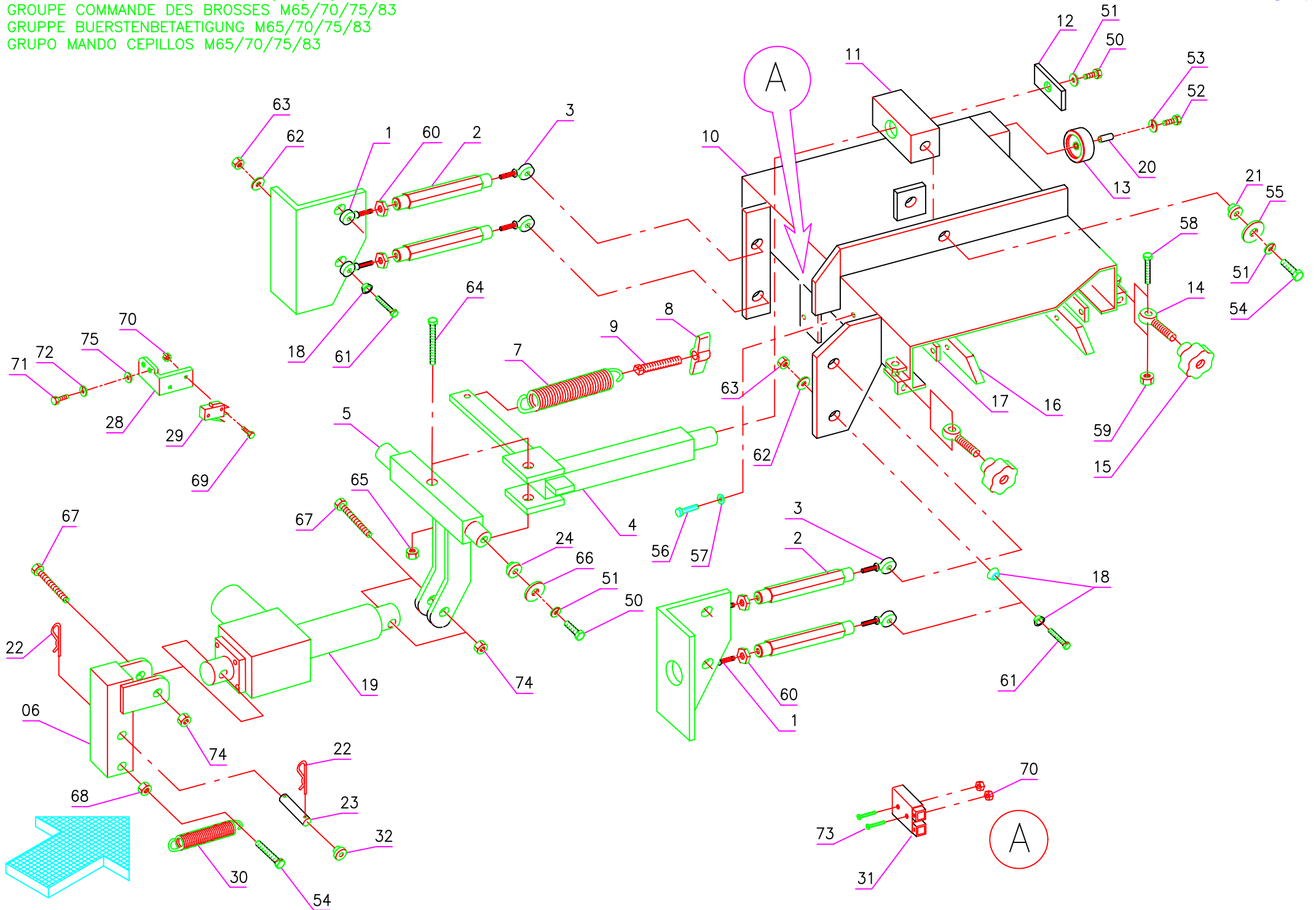

Pos.	Mod.	Codice	Q.tà	Denominazione	Denomination	Description	Benennung	Descripcion
1		T4806039	4	TESTA A SNODO SINISTRA	ARTICULATION HEAD LEFT	TETE ARTICULEE GAUCHE	KOPFGELENK, LINKS	TESTA DE ARTIC. IZQUIERDO
2		R2803050	4	BRACCIO ANTERIORE	ARM	BRAS	ARM	BRAZO
3		T4806040	4	TESTA A SNODO DESTRA	ARTICULATION HEAD RIGHT	TETE ARTICULEE DROITE	KOPFGELENK, RECHTS	TESTA DE ARTIC. DERECHO
4		R2803030	1	BRACCIO	ARM	BRAS	ARM	BRAZO
5		R2803020	1	ALBERO	SHAFT	ARBRE	LENKWELLE	EJE
6		R2803010	1	ATTACCO	COUPLING	ATTAQUE	KUPPLUNG	ACOPLAMIENTO
7		E9220170	1	MOLLA	SPRING	RESSORT	FEDER	RESORTE
8		T4008006	1	GALLETTO M8	WING NUT	PAPILLON	FLÜGELSCHRAUBE	POMO
9		R2703130	1	REGISTRO	ADJUSTER	REGISTRE	REGISTER	REGULADOR
10		R2802010	1	SUPPORTO	SUPPORT	SUPPORT	HALTERUNG	SOPORTE
11		R2803040	1	BLOCCHETTO	STOP RING	ANNEAU D'ARRET	BEFESTIGUNGSRING	ANILLO DE PARADA
12		R0130030	1	PIASTRINA	PLAQUE	PLAQUETTE	BEFESTIGUNGSAUFLAGE	PLAQUETA
13		E7020050	1	RUOTA PARACOLPI	WHEEL	ROUE	RAD	RUEDA
14		T4806042	2	TIRANTE	TIE ROD	TIGE	SPANNSTANGE	TIRANTE
15		T4008005	2	POMELLO	KNOB	POMMEAU	RENDELSCHRAUBE	POMO
16		R2802030	2	GUIDA	GUIDE	GUIDE	FÜHRUNG	GUIA
17		R2802040	2	SPESSORE	SHIM	EPAISSEUR	BEILAGERING	ESPEJOR
18		E9000270	16	DISTANZIALE	SPACER	ENTRETOISE	DISTANZHÜLSE	DISTANCIADOR
19		E6200100	1	MARTINETTO	ACTUATOR	VERIN	SPINDELMOTOR	GATO
20		E9103060	1	BOCCOLA	BUSHING	BAGUE	BUCHSE	CASQUILLO
21		E9100190	2	BOCCOLA	BUSHING	BAGUE	BUCHSE	CASQUILLO
22		T1600001	2	SPILLO Ø 2,4x47	CLIP	EPINGLE	SPLINT	ESPIGA
23		R2803070	1	PERNO	PIN	AXE	BOLZEN	PERNO
24		E9105050	2	BOCCOLA	BUSHING	BAGUE	BUCHSE	CASQUILLO
28		R2803060	1	STAFFA	SUPPORT	ATTAQUE	HALTERUNG	SOPORTE FIJADOR
29		T2105006	1	MICROINTERRUTTORE	MICROSWITCH	MICROINTERRUPTEUR	MIKROSHALTER	MICROINTERRUPTOR
30		E9220210	1	MOLLA	SPRING	RESSORT	FEDER	RESORTE
31		T2700001	1	CONNETTORE	CONNECTOR	CONNECTEUR	LADESTECKER	CONECTADOR
32		E9100370	2	BOCCOLA	BUSHING	BAGUE	BUCHSE	CASQUILLO
50				VITE M8x20 TE UNI 5739	SCREW	VIS	SCHRAUBE	TORNILLO
51				RONDELLA Ø 8 GROIWER	LOCK WASHER	RONDELLE FREIN	ZAHNSCHEIBE	ARANDELLA DENTADA
52				VITE M8x35 TE UNI 5739	SCREW	VIS	SCHRAUBE	TORNILLO
53				RONDELLA Ø 8x17 UNI 6592	WASHER	RONDELLE	UNTERLAGSCHEIBE	ARANDELA
54				VITE M8x25 TE UNI 5739	SCREW	VIS	SCHRAUBE	TORNILLO
55				RONDELLA Ø 8x24 UNI 6593	WASHER	RONDELLE	UNTERLAGSCHEIBE	ARANDELA
56				VITE M6x20 TE UNI 5739	SCREW	VIS	SCHRAUBE	TORNILLO
57				RONDELLA Ø 6 GROWER	LOCK WASHER	RONDELLE FREIN	ZAHNSCHEIBE	ARANDELLA DENTADA
58				VITE M6x30 TE UNI 5739 INOX	SCREW	VIS	SCHRAUBE	TORNILLO
59				DADO M6 AUT. UNI 7473 INOX	LOCK NUT	ECROU AUTOBLOQUANT	STOPMUTTER	TUERCA AUTOBLOCANTE
60				DADO M12 UNI 5589	NUT	ECROU	MUTTER	TUERCA
61				VITE M12x60 TE UNI 5737	SCREW	VIS	SCHRAUBE	TORNILLO
62				RONDELLA Ø 12x24 UNI 6592	WASHER	RONDELLE	UNTERLAGSCHEIBE	ARANDELA
63				DADO M12 AUTOBL. UNI 7474	LOCK NUT	ECROU AUTOBLOQUANT	STOPMUTTER	TUERCA AUTOBLOCANTE
64				VITE M8x55 TE UNI 5737	SCREW	VIS	SCHRAUBE	TORNILLO
65				DADO M8 AUTOBL UNI 7474	LOCK NUT	ECROU AUTOBLOQUANT	STOPMUTTER	TUERCA AUTOBLOCANTE
66				RONDELLA Ø 8x32 UNI 6592	WASHER	RONDELLE	UNTERLAGSCHEIBE	ARANDELA
67				VITE M10x60 TE UNI 5737	SCREW	VIS	SCHRAUBE	TORNILLO
68				DADO M8 UNI 5588	NUT	ECROU	MUTTER	TUERCA
69				VITE M3x16 TCTC UNI 7687	SCREW	VIS	SCHRAUBE	TORNILLO
70				DADO M3 AUTOBL. UNI 7474	LOCK NUT	ECROU AUTOBLOQUANT	STOPMUTTER	TUERCA AUTOBLOCANTE

TAV.04 rev.02 GRUPPO COMANDO SPAZZOLE M65/70/75/83 (PROFY-KLINIK LINE)

Pos.	Mod.	Codice	Q.tà	Denominazione	Denomination	Description	Benennung	Descripcion
71				VITE M5x12 TE UNI 5739	SCREW	VIS	SCHRAUBE	TORNILLO
72				RONDELLA Ø 5 GROWER	LOCK WASHER	RONDELLE FREIN	ZAHNSCHEIBE	ARANDELLA DENTADA
73				VITE M3x25 TCTC UNI 7687	SCREW	VIS	SCHRAUBE	TORNILLO
74				DADO M10 AUTOBL. UNI7473	LOCK NUT	ECROU AUTOBLOQUANT	STOPMUTTER	TUERCA AUTOBLOCANTE
75				RONDELLA Ø 5x10 UNI 6592	WASHER	RONDELLE	UNTERLAGSCHEIBE	ARANDELA

GRUPPO COMANDO SPAZZOLE M65/70/75/83 (BASIC/INDY-LINE)
BRUSHES CONTROL ASSEMBLY M65/70/75/83
GROUPE COMMANDE DES BROSSES M65/70/75/83
GRUPPE BUERSTENBETAETIGUNG M65/70/75/83
GRUPO MANDO CEPILLOS M65/70/75/83

04A

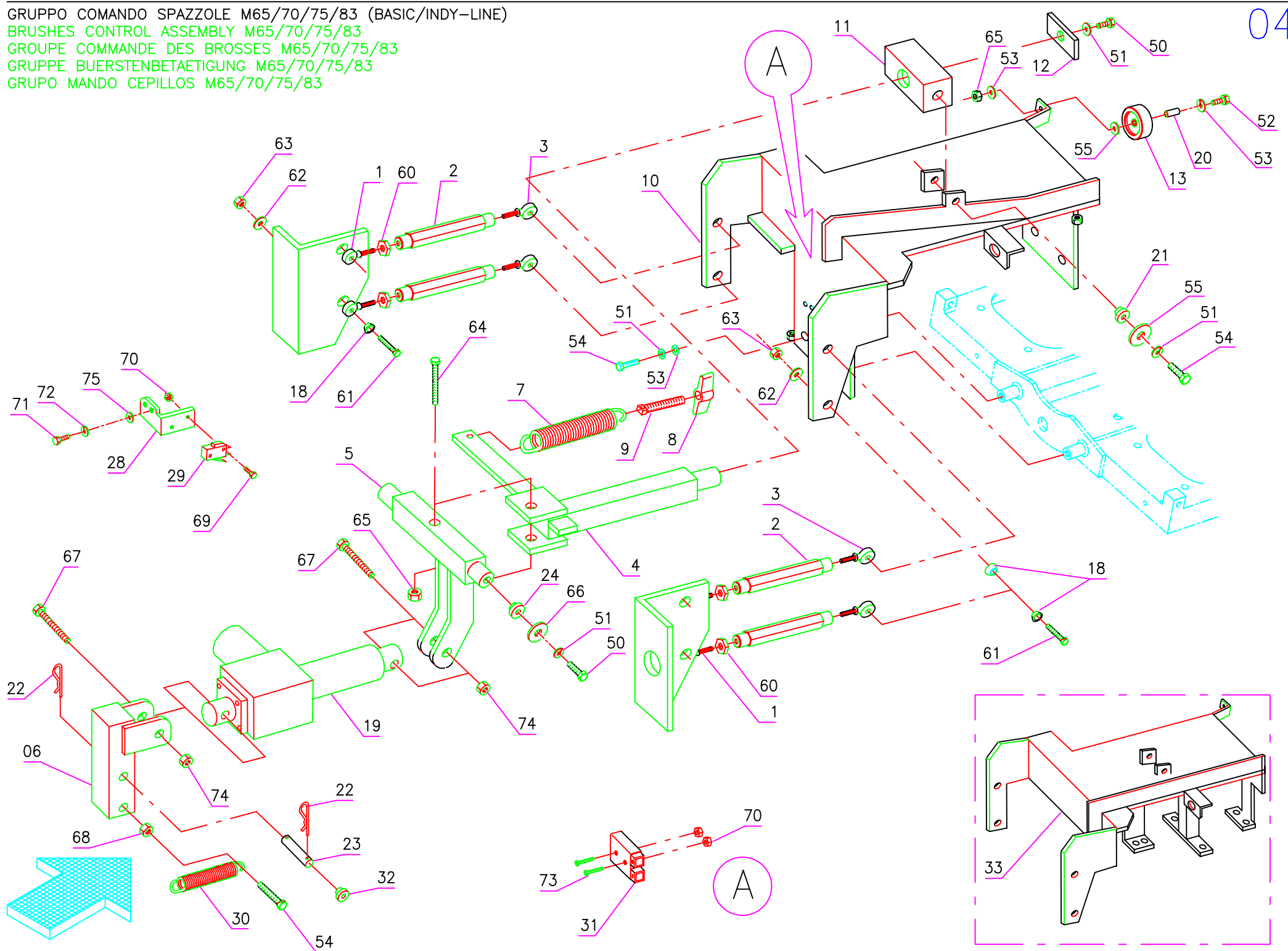

Pos	Mod.	Codice	Q.tà	Denominazione	Denomination	Description	Benennung	Descripcion
1		T4806039	4	TESTA A SNODO SINISTRA	ARTICULATION HEAD LEFT	TETE ARTICULEE GAUCHE	KOPFGELENK, LINKS	TESTA DE ARTIC. IZQUIERDO
2		R2803050	4	BRACCIO ANTERIORE	ARM	BRAS	ARM	BRAZO
3		T4806040	4	TESTA A SNODO DESTRA	ARTICULATION HEAD RIGHT	TETE ARTICULEE DROITE	KOPFGELENK, RECHTS	TESTA DE ARTIC. DERECHO
4		R2803030	1	BRACCIO	ARM	BRAS	ARM	BRAZO
5		R2803020	1	ALBERO	SHAFT	ARBRE	LENKWELLE	EJE
6		R2803010	1	ATTACCO	COUPLING	ATTAQUE	KUPPLUNG	ACOPLAMIENTO
7		E9220170	1	MOLLA	SPRING	RESSORT	FEDER	RESORTE
8		T4008006	1	GALLETTO M8	WING NUT	PAPILLON	FLÜGELSCHRAUBE	POMO
9		R2703130	1	REGISTRO	ADJUSTER	REGISTRE	REGISTER	REGULADOR
10	65/75/83	R2802050	1	SUPPORTO	SUPPORT	SUPPORT	HALTERUNG	SOPORTE
11		R2803040	1	BLOCCETTO	STOP RING	ANNEAU D'ARRET	BEFESTIGUNGSRING	ANILLO DE PARADA
12		R0130030	1	PIASTRINA	PLAQUE	PLAQUETTE	BEFESTIGUNGSAUFLAGE	PLAQUETA
13		E7020050	1	RUOTA PARACOLPI	WHEEL	ROUE	RAD	RUEDA
18		E9000270	16	DISTANZIALE	SPACER	ENTRETOISE	DISTANZHÜLSE	DISTANCIADOR
19		E6200100	1	MARTINETTO	ACTUATOR	VERIN	SPINDELMOTOR	GATO
20		E9103060	1	BOCCOLA	BUSHING	BAGUE	BUCHSE	CASQUILLO
21		E9100190	2	BOCCOLA	BUSHING	BAGUE	BUCHSE	CASQUILLO
22		T1600001	2	SPILLO Ø 2,4x47	CLIP	EPINGLE	SPLINT	ESPIGA
23		R2803070	1	PERNO	PIN	AXE	BOLZEN	PERNO
24		E9105050	2	BOCCOLA	BUSHING	BAGUE	BUCHSE	CASQUILLO
28		R2803060	1	STAFFA	SUPPORT	ATTAQUE	HALTERUNG	SOPORTE FIJADOR
29		T2105006	1	MICROINTERRUTTORE	MICROSWITCH	MICROINTERRUPTEUR	MIKROSHALTER	MICROINTERRUPTOR
30		E9220210	1	MOLLA	SPRING	RESSORT	FEDER	RESORTE
31		T2700001	1	CONNETTORE	CONNECTOR	CONNECTEUR	LADESTECKER	CONECTADOR
32		E9100370	2	BOCCOLA	BUSHING	BAGUE	BUCHSE	CASQUILLO
33	70	R2902020	1	SUPPORTO	SUPPORT	SUPPORT	HALTERUNG	SOPORTE
50				VITE M8x20 TE UNI 5739	SCREW	VIS	SCHRAUBE	TORNILLO
51				RONDELLA Ø 8 GROUWER	LOCK WASHER	RONDELLE FREIN	ZAHNSCHEIBE	ARANDELLA DENTADA
52				VITE M8x35 TE UNI 5739	SCREW	VIS	SCHRAUBE	TORNILLO
53				RONDELLA Ø 8x17 UNI 6592	WASHER	RONDELLE	UNTERLAGSCHEIBE	ARANDELLA
54				VITE M8x25 TE UNI 5739	SCREW	VIS	SCHRAUBE	TORNILLO
55				RONDELLA Ø 8x24 UNI 6593	WASHER	RONDELLE	UNTERLAGSCHEIBE	ARANDELLA
60				DADO M12 UNI 5589	NUT	ECROU	MUTTER	TUERCA
61				VITE M12x60 TE UNI 5737	SCREW	VIS	SCHRAUBE	TORNILLO
62				RONDELLA Ø 12x24 UNI 6592	WASHER	RONDELLE	UNTERLAGSCHEIBE	ARANDELLA
63				DADO M12 AUTOBL. UNI 7474	LOCK NUT	ECROU AUTOBLOQUANT	STOPMUTTER	TUERCA AUTOBLOCANTE
64				VITE M8x55 TE UNI 5737	SCREW	VIS	SCHRAUBE	TORNILLO
65				DADO M8 AUTOBL UNI 7474	LOCK NUT	ECROU AUTOBLOQUANT	STOPMUTTER	TUERCA AUTOBLOCANTE
66				RONDELLA Ø 8x32 UNI 6592	WASHER	RONDELLE	UNTERLAGSCHEIBE	ARANDELLA
67				VITE M10x60 TE UNI 5737	SCREW	VIS	SCHRAUBE	TORNILLO
68				DADO M8 UNI 5588	NUT	ECROU	MUTTER	TUERCA
69				VITE M3x16 TCTC UNI 7687	SCREW	VIS	SCHRAUBE	TORNILLO
70				DADO M3 AUTOBL. UNI 7474	LOCK NUT	ECROU AUTOBLOQUANT	STOPMUTTER	TUERCA AUTOBLOCANTE
71				VITE M5x12 TE UNI 5739	SCREW	VIS	SCHRAUBE	TORNILLO
72				RONDELLA Ø 5 GROWER	LOCK WASHER	RONDELLE FREIN	ZAHNSCHEIBE	ARANDELLA DENTADA
73				VITE M3x25 TCTC UNI 7687	SCREW	VIS	SCHRAUBE	TORNILLO
74				DADO M10 AUTOBL. UNI7473	LOCK NUT	ECROU AUTOBLOQUANT	STOPMUTTER	TUERCA AUTOBLOCANTE
75				RONDELLA Ø 5x10 UNI 6592	WASHER	RONDELLE	UNTERLAGSCHEIBE	ARANDELLA

GRUPPO STERZO M65/70/75/83
 STERRING GEAR M65/70/75/83
 ENSEMBLE DE VOLANT M65/70/75/83
 LENKGRUPPE M65/70/75/83
 GRUPO DE DIRECCION M65/70/75/83

	05 2907 3059
	05 2907 3060

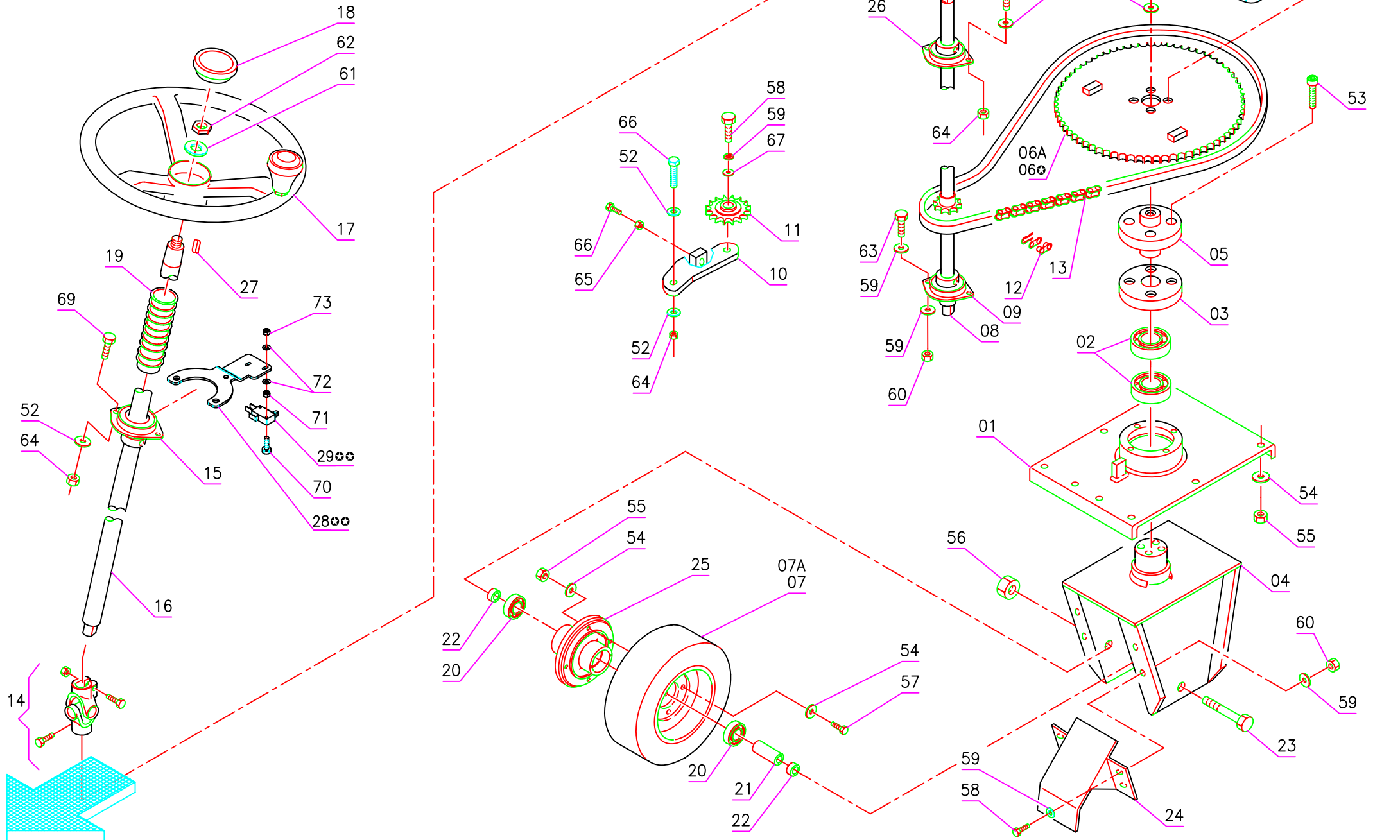

Pos.	Mod.	Codice	Q.tà	Denominazione	Denomination	Description	Benennung	Descripcion
1		R5016090	1	PIASTRA SUPPORTO RUOTA	PLATE	P.LAQUE	TELLER	PLACA
2		T0515002	2	CUSCINETTO 6010 2RS1	BEARING	ROULEMENT	LAGER	COJINETE
3		R5027040	1	PORTA CUSCINETTO	BOX	BOITE	SICHERUNG	CAJA
4		R2827050	1	SUPPORTO	SUPPORT	SUPPORT	HALTERUNG	SOPORTE
5		R5016110	1	MOZZO CORONA	HUB	MOYEU	NABE	BUJE
6		R2827060	1	CORONA STERZO	CROWN	COURONNE	KRONE	CORONA
6A		R2827090	1	CORONA STERZO	CROWN	COURONNE	KRONE	CORONA
7	*	E7030340	1	RUOTA ANTERIORE	WHEEL	ROUE	RAD	RUEDA
7A	**	E7030350	1	RUOTA ANT. ANTISKID	ANTISKID WHEEL	ROUE ANTISKID	ANTISKIDRAD	RUEDA DE ANTISKID
8		R2827020	1	ALBERO INFERIORE	SHAFT	ARBRE	LENKWELLE	EJE
9		T0541701	1	SUPPORTO BPFL 203	SUPPORT	SUPPORT	HALTERUNG	SOPORTE
10		R2827070	1	SUPPORTO TENDICATENA	SUPPORT	SUPPORT	HALTERUNG	SOPORTE
11		E9310070	1	TENDICATENA 1/2 Z=16	CHAIN TIGHTENER	TENDEUR DE CHAINE	KETTENSANNER	TENSOR DE CADENA
12		T0300002	1	GIUNZIONE CATENA	JOINT CHAIN	ATTACHE RAPID CHAINE	KETTENSCHLOSS	ESLABON
13		T0300012	1	CATENA	CHAIN	CHAINE	KETTE	CADENA
14		T5601001	1	CROCIERA STERZO	UNIVERSAL JOINT	JOINT UNIVERSEL	KREUZGELENK	ARTICULACION DE CARDAN
15		T0542502	1	SUPPORTO BPFL 205	SUPPORT	SUPPORT	HALTERUNG	SOPORTE
16		R2827010	1	ALBERO STERZO	SHAFT	ARBRE	WELLE	EJE
17		E9535010	1	VOLANTE	STEERING WHEEL	VOLANT	LENKRAD	VOLANTE
18		E9535011	1	TAPPO VOLANTE	PLUG	BOUCHON	DECKEL	TAPON
19		T4806006	1	SOFFIETTO	BELLOWS	SOUFFLET	FALTENBALG	FUELLE
20		T0512001	2	CUSCINETTO A 6204 2RS1	BEARING	ROULEMENT	LAGER	COJINETE
21		E9000240	1	DISTANZIALE INTERNO	SPACER	ENTRETOISE	DISTANZHÜLSE	DISTANCIADOR
22		E9000260	1	DISTANZIALE ESTERNO	SPACER	ENTRETOISE	DISTANZHÜLSE	DISTANCIADOR
23		R2827040	1	PERNO RUOTA	PIN	AXE	BOLZEN	PERNO
24		R2827080	1	PARAFANGO	MUDGUARD	AILE	KOTFLUEGEL	GUARDABARROS
25		E6920050	1	MOZZO RUOTA	WHEEL HUB	MOYEU ROUE	RADNABE	CUBO DE RUEDA
26		T0542001	1	SUPPORTO BPFL 204	SUPPORT	SUPPORT	HALTERUNG	SOPORTE
27		T0405051	1	LINGUETTA 5x5x20	TONGUE	LANGUETTE	PASSFEDER	TONGUE
28		R2827140	1	STAFFA SUPPORTO MICRO	BRACKET	ATTAQUE	BÜGEL	SOPORTE FIJADOR
29		T2105003	1	MICROINTERRUPTORE	MICROSWITCH	MICROINTERRUPTEUR	MIKROSCHALTER	MICROINTERRUPTOR
30		R2827150	1	PIASTRA COMANDO MICRO	PLAQUE	PLAQUETTE	AUFLAGE	PLACA
50		-	-	VITE M8x40 TE UNI 5739	SCREW	VIS	SCHRAUBE	TORNILLO
51		-	-	RONDELLA Ø 8 GROWER	WASHER	RONDELLE	UNTERLAGSCHEIBE	ARANDELA
52		-	-	RONDELLA Ø 8x17 UNI 6592	WASHER	RONDELLE	UNTERLAGSCHEIBE	ARANDELA
53		-	-	VITE M10x25 TCEI UNI 5931	SCREW	VIS	SCHRAUBE	TORNILLO
54		-	-	RONDELLA Ø 10x21 UNI 6592	WASHER	RONDELLE	UNTERLAGSCHEIBE	ARANDELA
55		-	-	DADO M10 AUTOBL. UNI 7474	LOCK NUT	ECROU AUTOBLOQUANT	STOPMUTTER	TUERCA AUTOBLOCANTE
56		-	-	DADO M20 AUTOBL. UNI 7474	LOCK NUT	ECROU AUTOBLOQUANT	STOPMUTTER	TUERCA AUTOBLOCANTE
57		-	-	VITE M10x35 TE UNI 5739	SCREW	VIS	SCHRAUBE	TORNILLO
58		-	-	VITE M6x16 TE UNI 5739	SCREW	VIS	SCHRAUBE	TORNILLO
59		-	-	RONDELLA Ø 6x12 UNI 6592	WASHER	RONDELLE	UNTERLAGSCHEIBE	ARANDELA
60		-	-	DADO M6 AUTOBL. UNI 7474	LOCK NUT	ECROU AUTOBLOQUANT	STOPMUTTER	TUERCA AUTOBLOCANTE
61		-	-	RONDELLA Ø 15x28 UNI 6592	WASHER	RONDELLE	UNTERLAGSCHEIBE	ARANDELA
62		-	-	DADO M14 UNI 5589	NUT	ECROU	MUTTER	TUERCA
63		-	-	VITE M6x20 TE UNI 5739	SCREW	VIS	SCHRAUBE	TORNILLO
64		-	-	DADO M8 AUTOBL. UNI 7474	LOCK NUT	ECROU AUTOBLOQUANT	STOPMUTTER	TUERCA AUTOBLOCANTE
65		-	-	DADO M8 UNI 5588	NUT	ECROU	MUTTER	TUERCA
66		-	-	VITE M8x60 TE UNI 5737	SCREW	VIS	SCHRAUBE	TORNILLO
67		-	-	ROND. Ø 6x24 UNI 6593	WASHER	RONDELLE	UNTERLAGSCHEIBE	ARANDELA
68		-	-	VITE M8x25 TE UNI 5739	SCREW	VIS	SCHRAUBE	TORNILLO

Pos.	Mod.	Codice	Q.tà	Denominazione	Denomination	Description	Benennung	Descripcion
69	-	-	-	VITE M8x20 TE UNI 5739	SCREW	VIS	SCHRAUBE	TORNILLO
70	-	-	-	VITE TE M3x25 UNI5739	SCREW	VIS	SCHRAUBE	TORNILLO
71	-	-	-	DADO M3 UNI5588	NUT	ECROU	MUTTER	TUERCA
72	-	-	-	ROSETTA M3 UNI6592	WASHER	RONDELLE	UNTERLAGSCHEIBE	ARANDELA
73	-	-	-	DADO AUTOBL. M3 UNI7474	LOCK NUT	ECROU AUTOBLOQUANT	STOPMUTTER	TUERCA AUTOBLOCANTE
74	-	-	-	VITE PTSEI M8x50 UNI5933	SCREW	VIS	SCHRAUBE	TORNILLO
75	-	-	-	VITE TE M8x45 UNI5739	SCREW	VIS	SCHRAUBE	TORNILLO
76	-	-	-	ROSETTA M8 DIN6797	LOCK WASHER	RONDELLE	ZAHNSCHEIBE	ARANDELA DENTADA

* BASIC/YNDY-LINE

** PROFY/KLINIK-LINE

GRUPPO TRAZIONE M65/70/783
TRACTION ASSEMBLY M65/70/75/83
GROUPE DE TRACTION M65/70/75/83
ANTRIEBSGRUPPE M65/70/75/83
GRUPO TRACCION M65/70/75/83

05 2907 3060

A

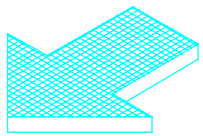
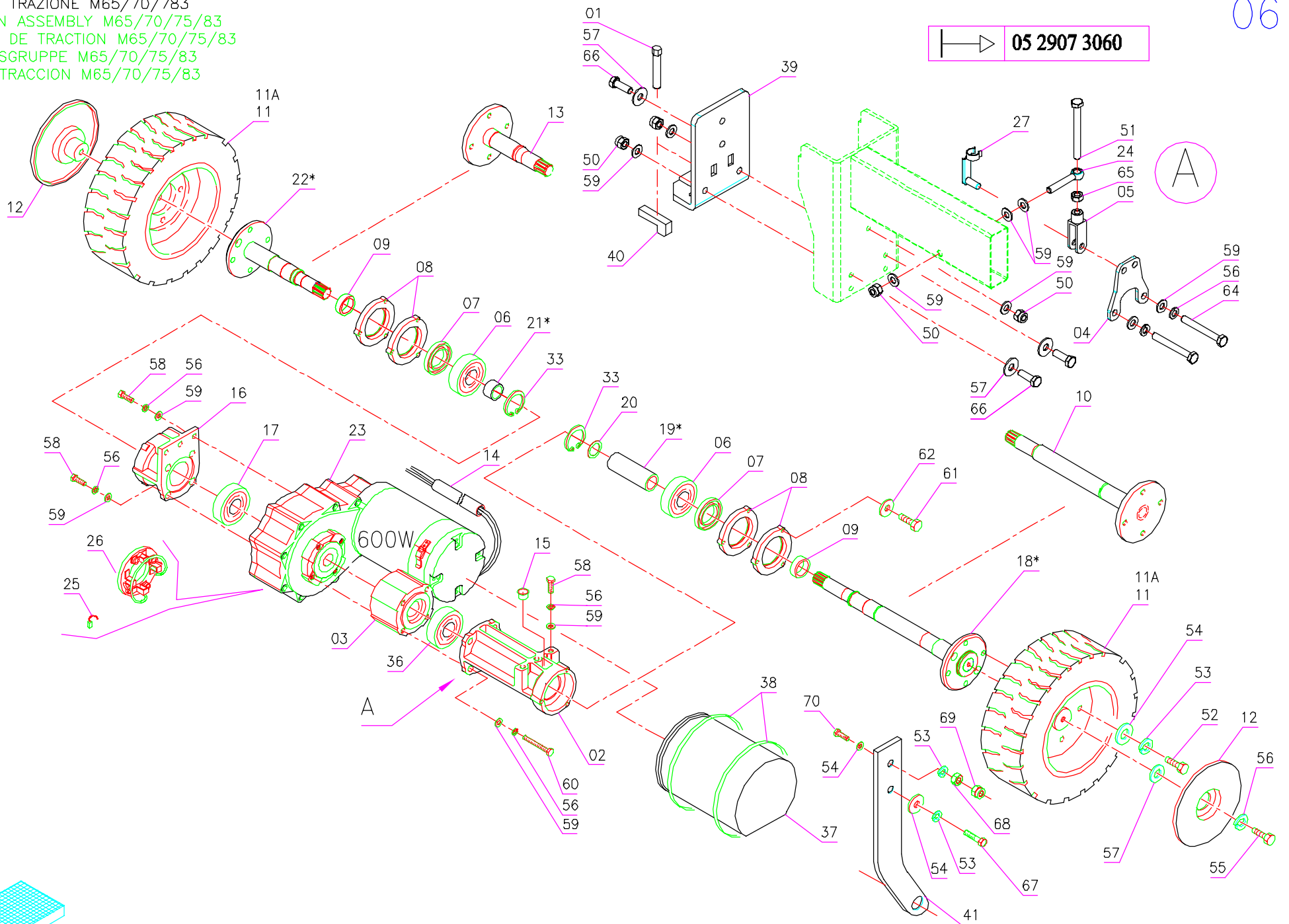

Pos.	Mod.	Codice	Q.tà	Denominazione	Denomination	Description	Benennung	Descripcion
1		42217050	1	PERNO FILETTATO	FILLETED PIVOT	PIVOT PASSEMENTÉ	SCHNEIDET EIN GEWINDE STÜTZE	GOZNE FILETEADO
2		R2830050	1	SUPPORTO ASSE SX	SUPPORT	SUPPORT	HALTERUNG	SOPORTE
3		T3501001	1	DISTANZIALE MOTORIDUTTORE	SPACER	ENTROTOISE	DISTANZHULSE	DISTANCIADOR
4		R2830080	1	STAFFA MOTORIDUTTORE	BRACKET	ATTAQUE	BÜGEL	SOPORTE FIJADOR
5		T4610004	1	FORCELLA M8x32	FORK	CHAPPE	GABELKOPF	HORQUILLA
6		T0512501	2	CUSCINETTO 6305 2RS1	BEARING	ROULEMENT	LAGER	COJINETE
7		T0732521	2	PARAOILIO Ø 32x52x7	OIL SEAL	JOINT PAULSTRA	SIMMERING	ARO RASCADOR DE ACEITE
8		R2830060	4	DISTANZIALE PORTACEPPI	SPACER	ENTROTOISE	DISTANZHULSE	DISTANCIADOR
9		E9000250	2	DISTANZIALE	SPACER	ENTRETOISE	DISTANZHÜLSE	DISTANCIADOR
10		E8928020	1	SEMIASSE SINISTRO	LEFT AXLE SHAFT	DEMI-ESSIEU GAUCHE	ACHSWELLE LINKS	SEMIEJE IZQUIERDO
11	*	E7030330	2	RUOTA	WHEEL	ROUE	RAD	RUEDA
11A	**	E7030360	2	RUOTA ANTISKID	ANTISKID WHEEL	ROUE ANTISKID	ANTISKIDRAD	RUEDA DE ANTISKID
12		R0617020	2	DISCO COPRIRUOTA	WHEEL COVER	COUVERCLE DE ROUE	RADDECKEL	CUBRERUEDA
13		E8928010	1	SEMIASSE DESTRO	RIGHT AXLE SHAFT	DEMI-ESSIEU DROITE	ACHSWELLE RECHTS	SEMIEJE DERECHO
14		E7404070	1	GUAINA 18x315	SHEAT	PAINE	MANTEL	VAINA
15		T2913003	1	TAPPO SALVAFILETTO	CAP	CAPUCHON	KAPPE	TAPON
16		R2830040	1	SUPPORTO ASSE DX	SUPPORT	SUPPORT	HALTERUNG	SOPORTE
17		T0512004	1	CUSCINETTO SF 6004 2RS1	BEARING	ROULEMENT	LAGER	COJINETE
18		E8928040	1	SEMIASSE SINISTRO	LEFT AXLE SHAFT	DEMI-ESSIEU GAUCHE	ACHSWELLE LINKS	SEMIEJE IZQUIERDO
19		E9000330	1	DISTANZIALE	SPACER	ENTRETOISE	DISTANZHÜLSE	DISTANCIADOR
20		T1225001	1	SPESSORE RAM 25x35x0.5	SHIM	EPAISSEUR	BEILAGERING	ESPEJOR
21		E9003060	1	DISTANZIALE	SPACER	ENTRETOISE	DISTANZHÜLSE	DISTANCIADOR
22		E8928030	1	SEMIASSE DESTRO	RIGHT AXLE SHAFT	DEMI-ESSIEU DROITE	ACHSWELLE RECHTS	SEMIEJE DERECHO
23		68200560	1	MOTORIDUTTORE 36V 600W	GEARED MOTOR	MOTO-REDUCTEUR	GETRIEBEMOTOR	MOTORREDUCTOR
24		R2830090	1	TIRANTE AD OCCHIO	TIE ROD	TIRANT	STANGE	VARRILLA
25		T1710182	4	SPAZZOLA MOTORE	CARBON BRUSH MOTOR	CHARBON MOTEUR	KOHLEBÜRSTE	ESCOBILLA MOTOR
26		72901058	1	PORTASPAZZOLE	CARBON BRUSH HOLDER	PORTE CHARBON	KOHLEBÜRSTENHALTERUNG	PORTAESCOBILLAS
27		T4620004	1	CLIPS PER FORCELLA M8x32	FORK PIN	AXE	BOLZEN	PERNO
33		T0220010	2	SEEGER E25	SEGER RING	SERRE CLIPS	SEEGERRING	ANILLO SEEGER
36		T0512003	1	CUSCINETTO 6304-2RS1	BEARING	ROULEMENT	LAGER	COJINETE
37		E7401060	1	CUFFIA MOTORE	SHROUD	JOINT	SAUGMOTORABDECKUNG	ANILLO DEL MOTOR
38		T4220001	2	FASCETTA PVC	CLAMP	COLLIER	BRIDE	ABRAZADERA
39		42217130	1	RINFORZO SUPPORTO RUOTE	I STRENGTHEN SUPPORT WHEELS	JE RENFORCE SUPPORT ROUES	ICH STÄRKE STÜTZE RÄDER	REFUERZO SOPORTE RUEDAS
40		42217140	1	SQUADRA DI RINFORZO	TEAM OF REINFORCEMENT	ÉQUIPE DE RENFORCEMENT	TEAM VON VERSTÄRKUNG	EQUIPO DE REFUERZO
41		R2816010	1	SUPPORTO	SUPPORT	SUPPORT	HALTERUNG	SOPORTE
50	-	-	-	DADO AUTOBL. M8 UNI7474	LOCK NUT	ECROU AUTOBLOQUANT	STOPMUTTER	TUERCA AUTOBLOCANTE
51	-	-	-	VITE TE M8x80 UNI5739	SCREW	VIS	SCHRAUBE	TORNILLO
52	-	-	-	VITE M10x25 TCEI UNI 5931	SCREW	VIS	SCHRAUBE	TORNILLO
53	-	-	-	RONDELLA Ø 10 GROWER	WASHER	RONDELLE	UNTERLAGSCHEIBE	ARANDELA
54	-	-	-	RONDELLA Ø 10x21 UNI 6592	WASHER	RONDELLE	UNTERLAGSCHEIBE	ARANDELA
55	-	-	-	VITE M8x20 TE UNI 5739	SCREW	VIS	SCHRAUBE	TORNILLO
56	-	-	-	RONDELLA Ø 8 GROWER	WASHER	RONDELLE	UNTERLAGSCHEIBE	ARANDELA
57	-	-	-	RONDELLA Ø 8x24 UNI 6593	WASHER	RONDELLE	UNTERLAGSCHEIBE	ARANDELA
58	-	-	-	VITE M8x25 TE UNI 5739	SCREW	VIS	SCHRAUBE	TORNILLO
59	-	-	-	RONDELLA Ø 8x17 UNI 6592	WASHER	RONDELLE	UNTERLAGSCHEIBE	ARANDELA
60	-	-	-	VITE M8x60 TE UNI 5739	SCREW	VIS	SCHRAUBE	TORNILLO
61	-	-	-	VITE M6x40 TCEI UNI 5931	SCREW	VIS	SCHRAUBE	TORNILLO
62	-	-	-	RONDELLA Ø 6 GROWER	WASHER	RONDELLE	UNTERLAGSCHEIBE	ARANDELA
63	-	-	-	VITE M10x80 TE UNI 5737	SCREW	VIS	SCHRAUBE	TORNILLO
64	-	-	-	VITE TE M8x70 UNI5739	SCREW	VIS	SCHRAUBE	TORNILLO

Pos.	Mod.	Codice	Q.tà	Denominazione	Denomination	Description	Benennung	Descripcion
65		-	-	DADO M8 UNI5588	NUT	ECROU	MUTTER	TUERCA
66		-	-	VITE TE M8x25 UNI5739	SCREW	VIS	SCHRAUBE	TORNILLO
67		-	-	VITE TE M10x25 UNI5739	SCREW	VIS	SCHRAUBE	TORNILLO
68		-	-	DADO M10 UNI5588	NUT	ECROU	MUTTER	TUERCA
69		-	-	DADO AUTOBL. M10 UNI7474	LOCK NUT	ECROU AUTOBLOQUANT	STOPMUTTER	TUERCA AUTOBLOCANTE
70		-	-	VITE TE M10x40 UNI5739	SCREW	VIS	SCHRAUBE	TORNILLO
☺		M2130001	1	KIT MOTORE TRAZIONE 600W	KIT TRAVEL DRIVE MOTOR 600W	KIT MOTEUR DE TRACTION 600W	SONDERAUSSTATTUNG FAHRMOTOR 600W	KIT MOTOR TRACCIÓN 600W

* BASIC/YNDY-LINE

** PROFY/KLINIK-LINE

GRUPPO TRAZIONE M65/70/783
 TRACTION ASSEMBLY M65/70/75/83
 GROUPE DE TRACTION M65/70/75/83
 ANTRIEBSGRUPPE M65/70/75/83
 GRUPO TRACCION M65/70/75/83

06A

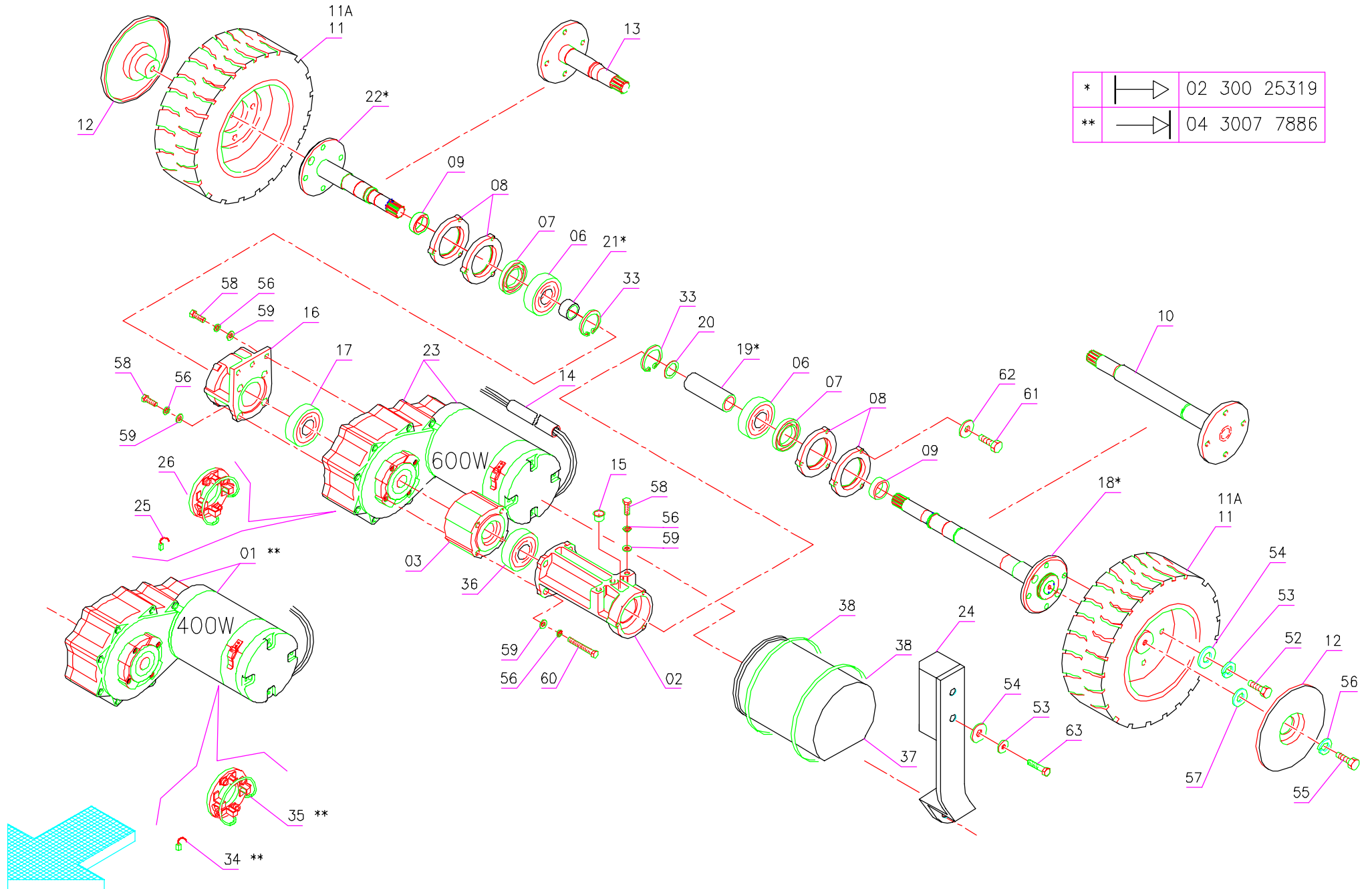

Pos.	Mod.	Codice	Q.tà	Denominazione	Denomination	Description	Benennung	Descripcion
1		E8230330	1	MOTORIDUTTORE 36V 450W	GEARED MOTOR	MOTO-REDUCTEUR	GETRIEBEMOTOR	MOTORREDUCTOR
2		R2830050	1	SUPPORTO ASSE SX	SUPPORT	SUPPORT	HALTERUNG	SOPORTE
3		T3501001	1	DISTANZIALE MOTORIDUTTORE	SPACER	ENTROTOISE	DISTANZHULSE	DISTANCIADOR
6		T0512501	2	CUSCINETTO 6305 2RS1	BEARING	ROULEMENT	LAGER	COJINETE
7		T0732521	2	PARAOILIO Ø 32x52x7	OIL SEAL	JOINT PAULSTRA	SIMMERING	ARO RASCADOR DE ACEITE
8		R2830060	4	DISTANZIALE PORTACEPPI	SPACER	ENTROTOISE	DISTANZHULSE	DISTANCIADOR
9		E9000250	2	DISTANZIALE	SPACER	ENTRETOISE	DISTANZHÜLSE	DISTANCIADOR
10		E8928020	1	SEMIASSE SINISTRO	LEFT AXLE SHAFT	DEMI-ESSIEU GAUCHE	ACHSWELLE LINKS	SEMIEJE IZQUIERDO
11	*	E7030330	2	RUOTA	WHEEL	ROUE	RAD	RUEDA
11A	**	E7030360	2	RUOTA ANTISKID	ANTISKID WHEEL	ROUE ANTISKID	ANTISKIDRAD	RUEDA DE ANTISKID
12		R0617020	2	DISCO COPRIRUOTA	WHEEL COVER	COUVERCLE DE ROUE	RADDECKEL	CUBRERUEDA
13		E8928010	1	SEMIASSE DESTRO	RIGHT AXLE SHAFT	DEMI-ESSIEU DROITE	ACHSWELLE RECHTS	SEMIEJE DERECHO
14		E7404070	1	GUAINA 18x315	SHEAT	PAINE	MANTEL	VAINA
15		T2913003	1	TAPPO SALVAFILETTO	CAP	CAPUCHON	KAPPE	TAPON
16		R2830040	1	SUPPORTO ASSE DX	SUPPORT	SUPPORT	HALTERUNG	SOPORTE
17		T0512004	1	CUSCINETTO SF 6004 2RS1	BEARING	ROULEMENT	LAGER	COJINETE
18		E8928040	1	SEMIASSE SINISTRO	LEFT AXLE SHAFT	DEMI-ESSIEU GAUCHE	ACHSWELLE LINKS	SEMIEJE IZQUIERDO
19		E9000330	1	DISTANZIALE	SPACER	ENTRETOISE	DISTANZHÜLSE	DISTANCIADOR
20		T1225001	1	SPESORE RAM 25x35x0.5	SHIM	EPAISSEUR	BEILAGERING	ESPESOR
21		E9003060	1	DISTANZIALE	SPACER	ENTRETOISE	DISTANZHÜLSE	DISTANCIADOR
22		E8928030	1	SEMIASSE DESTRO	RIGHT AXLE SHAFT	DEMI-ESSIEU DROITE	ACHSWELLE RECHTS	SEMIEJE DERECHO
23	⊕	E8230380	1	MOTORIDUTTORE 36V 600W	GEARED MOTOR	MOTO-REDUCTEUR	GETRIEBEMOTOR	MOTORREDUCTOR
24	⊕	R2816020	1	SUPPORTO	SUPPORT	SUPPORT	HALTERUNG	SOPORTE
25		T1710182	4	SPAZZOLA MOTORE	CARBON BRUSH MOTOR	CHARBON MOTEUR	KOHLEBÜRSTE	ESCOBILLA MOTOR
26		T1700027	1	PORTASPAZZOLE	CARBON BRUSH HOLDER	PORTE CHARBON	KOHLEBÜRSTENHALTERUNG	PORTAESCOBILLAS
33		T0220010	2	SEEGER E25	SEEGER RING	SERRE CLIPS	SEEGERRING	ANILLO SEEGER
34		T1707141	4	SPAZZOLA MOTORE	CARBON BRUSH MOTOR	CHARBON MOTEUR	KOHLEBÜRSTE	ESCOBILLA MOTOR
35		T1700002	1	PORTASPAZZOLE	CARBON BRUSH HOLDER	PORTE CHARBON	KOHLEBÜRSTENHALTERUNG	PORTAESCOBILLA
36		T0512003	1	CUSCINETTO 6304-2RS1	BEARING	ROULEMENT	LAGER	COJINETE
37		E7401060	1	CUFFIA MOTORE	SHROUD	JOINT	SAUGMOTORABDECKUNG	ANILLO DEL MOTOR
38		T4220001	2	FASCETTA PVC	CLAMP	COLLIER	BRIDE	ABRAZADERA
52		-	-	VITE M10x25 TCEI UNI 5931	SCREW	VIS	SCHRAUBE	TORNILLO
53		-	-	RONDELLA Ø 10 GROWER	WASHER	RONDELLE	UNTERLAGSCHEIBE	ARANDELA
54		-	-	RONDELLA Ø 10x21 UNI 6592	WASHER	RONDELLE	UNTERLAGSCHEIBE	ARANDELA
55		-	-	VITE M8x20 TE UNI 5739	SCREW	VIS	SCHRAUBE	TORNILLO
56		-	-	RONDELLA Ø 8 GROWER	WASHER	RONDELLE	UNTERLAGSCHEIBE	ARANDELA
57		-	-	RONDELLA Ø 8x24 UNI 6593	WASHER	RONDELLE	UNTERLAGSCHEIBE	ARANDELA
58		-	-	VITE M8x25 TE UNI 5739	SCREW	VIS	SCHRAUBE	TORNILLO
59		-	-	RONDELLA Ø 8x17 UNI 6592	WASHER	RONDELLE	UNTERLAGSCHEIBE	ARANDELA
60		-	-	VITE M8x60 TE UNI 5739	SCREW	VIS	SCHRAUBE	TORNILLO
61		-	-	VITE M6x40 TCEI UNI 5931	SCREW	VIS	SCHRAUBE	TORNILLO
62		-	-	RONDELLA Ø 6 GROWER	WASHER	RONDELLE	UNTERLAGSCHEIBE	ARANDELA
63		-	-	VITE M10x80 TE UNI 5737	SCREW	VIS	SCHRAUBE	TORNILLO
⊕		M2130001	1	KIT MOTORE TRAZIONE 600W	KIT TRAVEL DRIVE MOTOR 600W	KIT MOTEUR DE TRACTION 600W	SONDERAUSSTATTUNG FAHRMOTOR 600W	KIT MOTOR TRACCIÓN 600W

* BASIC/YNDY-LINE

** PROFY/KLINIK-LINE

GRUPPO FRENO E RUOTE M65/70/75/83
BRAKE AND WHEELS ASSEMBLY M65/70/75/83
ENSEMBLE DE FREIN ET ROUES M65/70/75/83
BREMSANLAGE-HINTERRAEDER M65/70/75/83
GRUPO FRENO Y RUEDAS M65/70/75/83

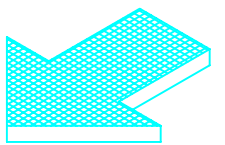
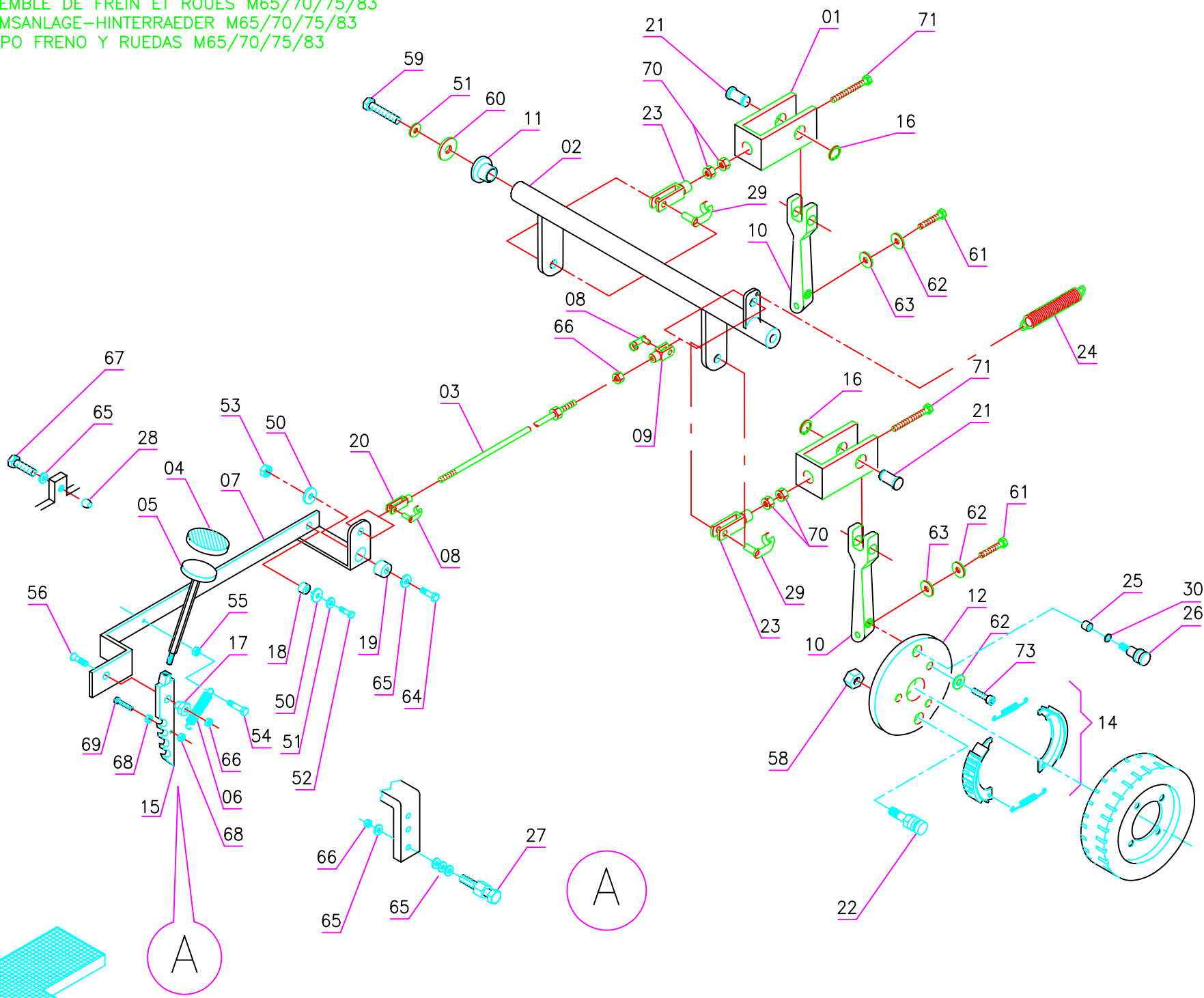

A

A

Pos.	Mod.	Codice	Q.tà	Denominazione	Denomination	Description	Benennung	Descripcion
1		R2818050	2	FORCELLA FRENO	FORK	CHAPPE	GABELKOPF	HORQUILLA
2		R2818010	1	ALBERO	SHAFT	ARBRE	LENKWELLE	EJE
3		R2818090	1	ASTA	ROD	TIGE	STANGE	VARILLA
4		R2718070	1	COPRIPEDALE	PEDAL COVER	GARNITURE PEDALE	PEDALGUMMI	CUBREPEDAL
5		R2818110	1	PEDALE	PEDAL	PEDALE	PEDAL	PEDAL
6		E9220080	1	MOLLA	SPRING	RESSORT	FEDER	RESORTE
7		R2818060	1	LEVA	LEVER	LEVIER	HEBEL	PALANCA
8		T4620004	2	CLIPS PER FORCELLA	FORK PIN	AXE	BOLZEN	PERNO
9		T4610004	1	FORCELLA	FORK	FOURCHE	GABEL	HORQUILLA
10		T4803031	2	LEVA	LEVER	LEVIER	HEBEL	PALANCA
11		E9105050	2	BOCCOLA	BUSHING	BAGUE	BUCHSE	CASQUILLO
12		R2817010	2	PORTACEPPI	BRAKE SHOE-HOLDER	PORTE-SABOT	BACKETRAEGER	PLATO-PORTACEPILLO
14		T4803048	2	ANELLO A CEPPI COMPLETO	BRAKE ASSY	ENSEMBLE FREIN	BREMSANLAGE	GRUPO FRENO
15		R2818070	1	LEVA BLOCCO	LEVER	LEVIER	HEBEL	PALANCA
16		T0220009	2	SEEGER E12	SEEGER RING	SERRE CLIPS	SEEGERRING	ANILLO SEEGER
17		E9100380	1	BOCCOLA	BUSHING	BAGUE	BUCHSE	CASQUILLO
18		E9100190	1	BOCCOLA	BUSHING	BAGUE	BUCHSE	CASQUILLO
19		R2818040	1	DISTANZIALE	SPACER	ENTRETOISE	DISTANZHÜLSE	DISTANCIADOR
20		T4610007	1	FORCELLA M8x32 SINISTRA	FORK, LEFT	CHAPPE, GAUCHE	GABELKOPF, LINKS	HORQUILLA, IZQUIERDO
21		R2818080	2	PERNO	PIN	AXE	BOLZEN	PERNO
22		R2817020	2	PERNO	PIN	AXE	BOLZEN	PERNO
23		T4610003	2	FORCELLA M6 LUNGA	FORK	CHAPPE	GABELKOPF	HORQUILLA
24		E9220120	1	MOLLA	SPRING	RESSORT	FEDER	RESORTE
25		E9102140	2	BOCCOLA	BUSHING	BAGUE	BUCHSE	CASQUILLO
26		T4803049	2	PERNO	PIN	AXE	BOLZEN	PERNO
27		R2818030	1	PERNO BLOCCO	PIN	AXE	BOLZEN	PERNO
28		T4806004	1	PIEDINO	CAP	BOUCHON	STOPFEN	TAPON
29		T4620002	2	CLIPS PER FORCELLA	FORK PIN	AXE	BOLZEN	PERNO
30		T0800011	2	GUARNIZIONE OR	O-RING	JOINT	O-RING	JUNTA ANULAR
50				RONDELLA Ø 8x24 UNI 6593	WASHER	RONDELLE	UNTERLAGSCHEIBE	ARANDELA
51				RONDELLA Ø 8 GROWER	WASHER	RONDELLE	UNTERLAGSCHEIBE	ARANDELA
52				VITE M8x25 TE UNI 5739	SCREW	VIS	SCHRAUBE	TORNILLO
53				DADO M8 AUTOBL. UNI 7474	LOCK NUT	ECROU AUTOBLOQUANT	STOPMUTTER	TUERCA AUTOBLOCANTE
54				VITE M5x35 TE UNI 5739	SCREW	VIS	SCHRAUBE	TORNILLO
55				DADO M5 UNI 5588	NUT	ECROU	MUTTER	TUERCA
56				VITE M8x20 TPSEI UNI 5933	SCREW	VIS	SCHRAUBE	TORNILLO
58				DADO M10 AUTOBL. UNI 7474	LOCK NUT	ECROU AUTOBLOQUANT	STOPMUTTER	TUERCA AUTOBLOCANTE
59				VITE M8x20 TE UNI 5739	SCREW	VIS	SCHRAUBE	TORNILLO
60				RONDELLA Ø 8x32 UNI 6593	WASHER	RONDELLE	UNTERLAGSCHEIBE	ARANDELA
61				VITE M6x25 TE UNI 5739	SCREW	VIS	SCHRAUBE	TORNILLO
62				RONDELLA Ø 6 GROWER	WASHER	RONDELLE	UNTERLAGSCHEIBE	ARANDELA
63				RONDELLA Ø 6x12 UNI 6592	WASHER	RONDELLE	UNTERLAGSCHEIBE	ARANDELA
64				VITE M8x45 TE UNI 5739	SCREW	VIS	SCHRAUBE	TORNILLO
65				RONDELLA Ø 8x17 UNI 6592	WASHER	RONDELLE	UNTERLAGSCHEIBE	ARANDELA
66				DADO M8 UNI 5588	NUT	ECROU	MUTTER	TUERCA
67				VITE M8x20 UNI 5739	SCREW	VIS	SCHRAUBE	TORNILLO
68				DADO M4 UNI 5588	NUT	ECROU	MUTTER	TUERCA
69				VITE M4x25 TE UNI 5739	SCREW	VIS	SCHRAUBE	TORNILLO
70				DADO M6 UNI 5588	NUT	ECROU	MUTTER	TUERCA
71				VITE M6x50 TE UNI 5739	SCREW	VIS	SCHRAUBE	TORNILLO

TAV.07 rev.03

GRUPPO FRENO E RUOTE M65/70/75/83

Pos.	Mod.	Codice	Q.tà	Denominazione	Denomination	Description	Benennung	Descripcion
73				VITE M6x40 TC UNI 5931	SCREW	VIS	SCHRAUBE	TORNILLO

GRUPPO SERBATOIO SOLUZIONE M65/70/75/83
SOLUTION TANK ASSEMBLY M65/70/75/83
GROUPE DE RESERVOIR EAU PROPRE M65/70/75/83
GRUPPE LAUGETANK M65/70/75/83
GRUPO TANQUE SOLUCION M65/70/75/83

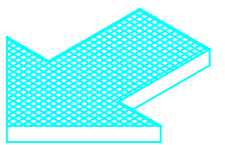
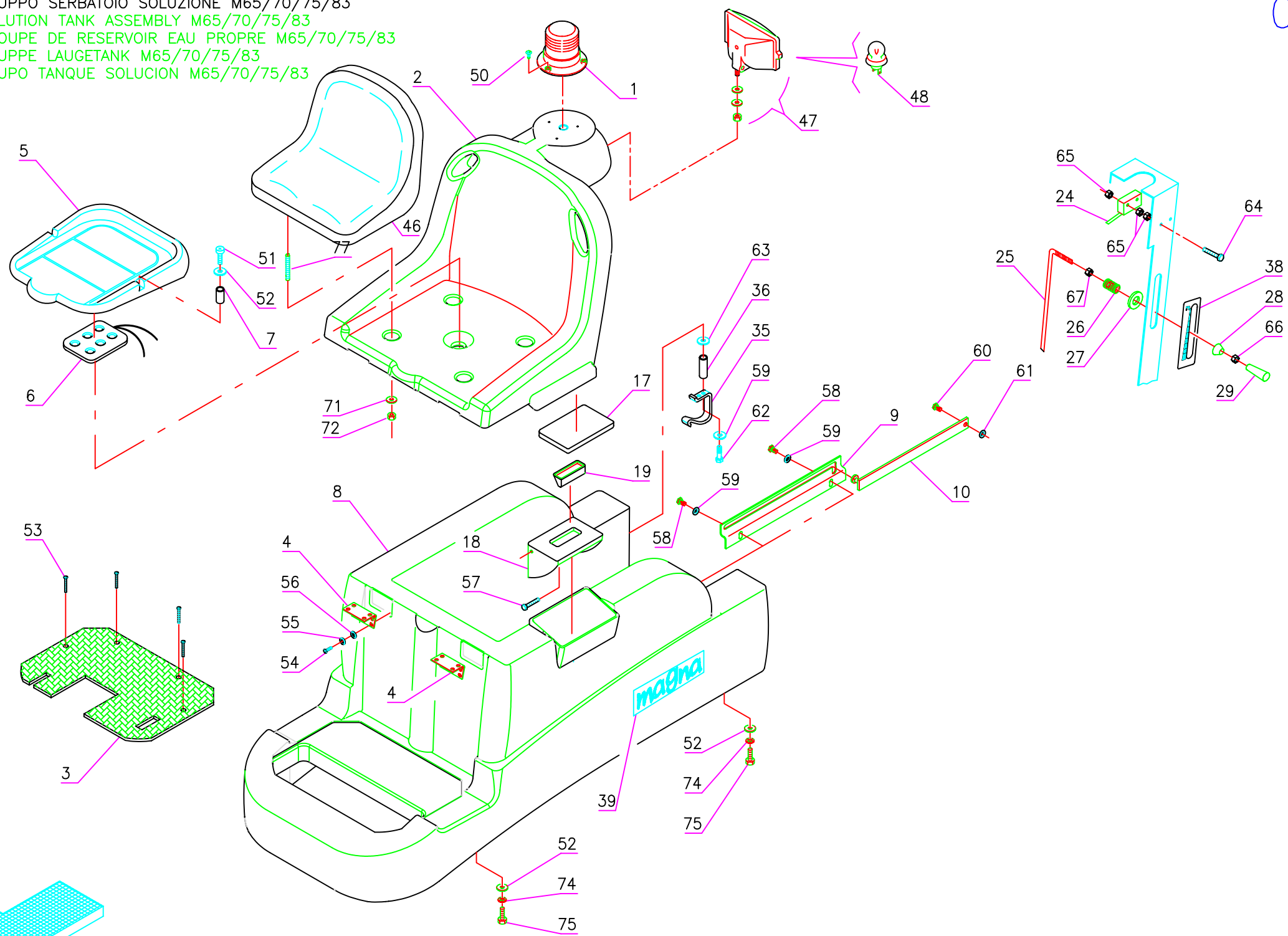

Pos.	Mod.	Codice	Q.tà	Denominazione	Denomination	Description	Benennung	Descripcion
1		T2905004	1	LAMPEGGIATORE 12-80 V	WINKING LIGHT	CLIGNOTEUR	BLINKANLAGE	DESTELLADOR
2		R2846020	1	SUPPORTO SEDILE	SEAT SUPPORT	SUPPORT DU SIEGE	SITZHALTERUNG	SOPORTE ASIENTO
3		R2846030	1	PEDANA POGGIAPIEDI	BOTTOM PLATE	REPOSE PIED	BODENBLECH	PLATAFORMA
4		R2846080	2	CERNIERA	HINGE	CHARNIERE	SCHARNER	BISAGRA
5		R2846090	1	SEDILE	SEAT	SIEGE	SITZ	ASIENTO
6		T2105004	1	MICROINTERRUTTORE	MICROSWITCH	MICROINTERRUPTEUR	MIKROSHALTER	MICROINTERRUPTOR
7		E9030070	2	DISTANZIALE	SPACER	ENTRETOISE	DISTANZHÜLSE	DISTANCIADOR
8		E9728010	1	SERBATOIO SOLUZIONE	SOLUTION TANK	RESERVOIR EAU PROPRE	LAUGENTANK	TANQUE SOLUCION
9		R2836020	1	STAFFA PUNTELLO	SUPPORT	SUPPORT	HALTERUNG	SOPORTE
10		R2836010	1	PUNTELLO	PROP	LEVIER	STÜTZE	PUNTAL
17		E7400380	1	GUARNIZIONE	GASKET	GARNITURE	DICHTUNG	JUNTA
18		R2836030	1	SPORTELLO	DOOR	PORTE	TUER	VENTANILLA
19		T4100018	1	MANIGLIA SPORTELLO	LEVER	MANETTE	HANDHEBEL	PALANCA
24		T2105006	1	MICROINTERRUTTORE	MICROSWITCH	MICROINTERRUPTEUR	MIKROSHALTER	MICROINTERRUPTOR
25		R2837010	1	ASTA RUBINETTO	ROD	TIGE	STANGE	VARILLA
26		E9210080	1	MOLLA	SPRING	RESSORT	FEDER	RESORTE
27		T1106012	1	RONDELLA Ø 6x30x3 PVC	WASHER	RONDELLE	UNTERLAGSCHEIBE	ARANDELA
28		R1316010	1	RONDELLA SOTTO VITE	WASHER	RONDELLE	UNTERLAGSCHEIBE	ARANDELA
29		T4100004	1	MANOPOLA M5	KNOB	POIGNEE	DREHGRIFF	EMPUÑADURA
35		R2736070	1	AGGANCIO	COUPLER	CROCHET	ARRETIERUNG	GANCHO
36		E9113050	1	DISTANZIALE	SPACER	ENTRETOISE	DISTANZHÜLSE	DISTANCIADOR
38		E6410087	1	ETICHETTA RUBINETTO	DECAL	ETIQUETTE	SCHILD	ETIQUETA
39		E6410304	2	ETICHETTA	DECAL	ETIQUETTE	SCHILD	ETIQUETA
46	PROFY	E5900010	1	SEDILE "CONFORT"	SEAT	SIEGE	SITZ	ASIENTO
47	INDY	T2300213	1	FARO (SENZA LAMPADA)	HEAD LIGHT (WITHOUT BULB)	PROJECTEUR (SANS AMPOULE)	ARBEITSLICHT (OHNE LAMPE)	FARO (SIN LAMPARA)
48	INDY	T2300001	1	LAMPADA 24V 70W	ELECTRIC BULB	AMPOULE	GLÜHLAMPE	LAMPARA
50				VITE Ø 4.2x13 AUTOFIL. UNI 6954	SCREW	VIS	SCHRAUBE	TORNILLO
51				VITE M6x30 TE UNI 5739	SCREW	VIS	SCHRAUBE	TORNILLO
52				RONDELLA Ø 6x18 UNI 6593	WASHER	RONDELLE	UNTERLAGSCHEIBE	ARANDELA
53				VITE M6x16 TPSEI UNI 5933	SCREW	VIS	SCHRAUBE	TORNILLO
54				VITE M5x12 TE UNI 5739	SCREW	VIS	SCHRAUBE	TORNILLO
55				RONDELLA Ø 5 GROWER	LOCK WASHER	RONDELLE FREIN	ZAHNSCHEIBE	ARANDELA DENTADA
56				RONDELLA Ø 5x10 UNI 6592	WASHER	RONDELLE	UNTERLAGSCHEIBE	ARANDELA
57				VITE M4x20 TSPTC UNI 7687	SCREW	VIS	SCHRAUBE	TORNILLO
58				VITE M6x20 TE UNI 5739	SCREW	VIS	SCHRAUBE	TORNILLO
60				VITE M8x25 TE UNI 5739	SCREW	VIS	SCHRAUBE	TORNILLO
61				RONDELLA Ø 8x24 UNI 6593	WASHER	RONDELLE	UNTERLAGSCHEIBE	ARANDELA
62				VITE M6x50 TE UNI 5739	SCREW	VIS	SCHRAUBE	TORNILLO
63				RONDELLA Ø 6x24 UNI 6593	WASHER	RONDELLE	UNTERLAGSCHEIBE	ARANDELA
64				VITE M3x40 TCTC UNI 7985	SCREW	VIS	SCHRAUBE	TORNILLO
65				DADO M3 OTTONE	NUT	ECROU	MUTTER	TUERCA
66				DADO M5 UNI 5588	NUT	ECROU	MUTTER	TUERCA
67				DADO M5 SERPRESS	NUT	ECROU	MUTTER	TUERCA
75				VITE M6x20 TE UNI 5739	SCREW	VIS	SCHRAUBE	TORNILLO
77				GRANO M8x60 UNI 5929	DOWEL	VIS	MADENSCHRAUBE	TORNILLO

GRUPPO SERBATOIO RECUPERO M65/70/75/83
 RECOVERY TANK ASSEMBLY M65/70/75/83
 GROUPE DE RESERVOIR EAU SALE M65/70/75/83
 GRUPPE SCHMUTZWASSERTANK M65/70/75/83
 GRUPO TANQUE AGUA SUCIA M65/70/75/83

★	→	05 2805 5628
★★	→	05 2805 5629

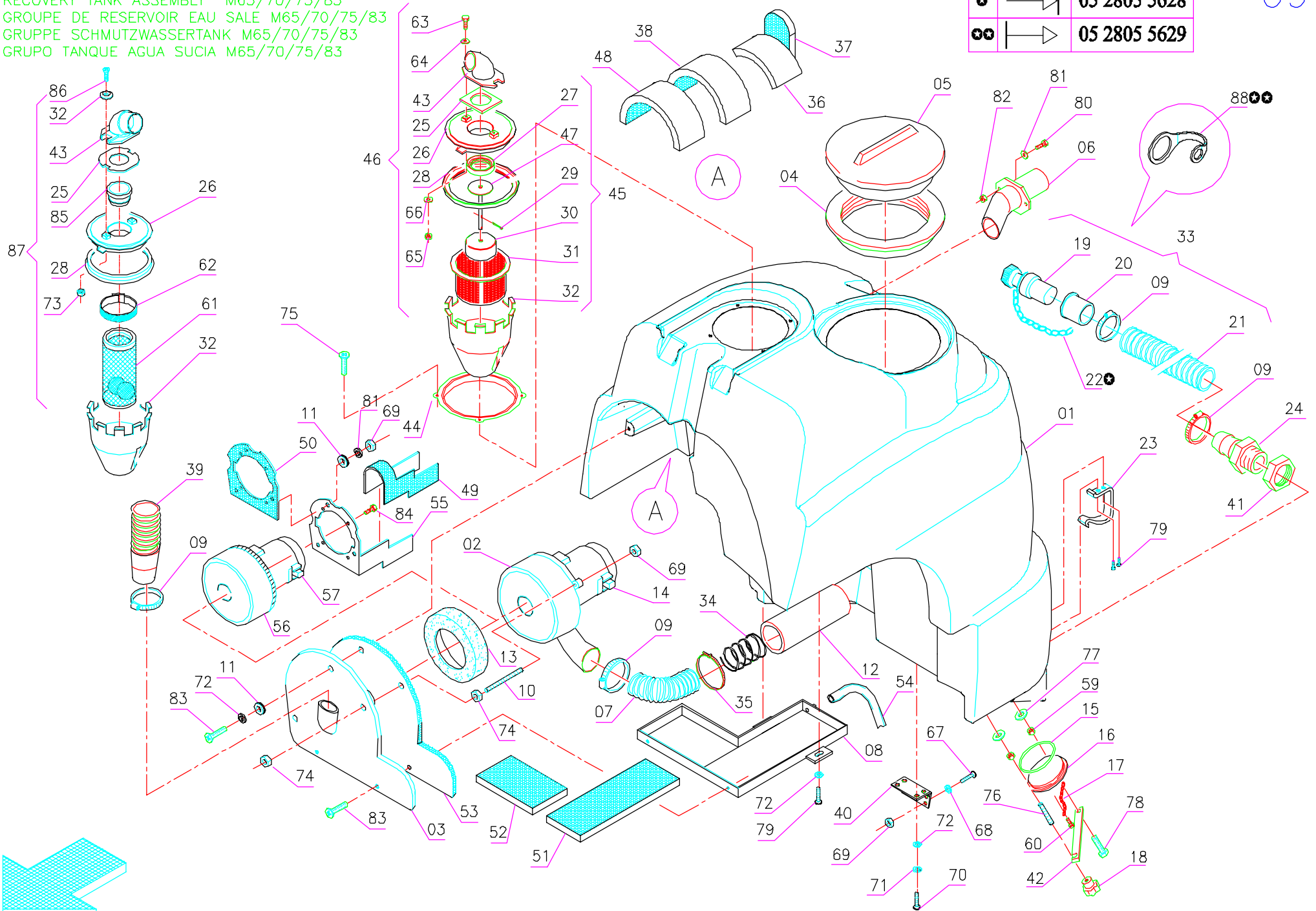

Pos.	Mod.	Codice	Q.tà	Denominazione	Denomination	Description	Benennung	Descripcion
1		E9728020	1	SERBATOIO RECUPERO	RECOVERY TANK	RESERVOIR EAU SALE	SCHMUTZWASSERTANK	TANQUE AGUA SUCIA
2		M2810050	1	MOTORE ASPIRAZIONE	SUCTION MOTOR	MOTEUR D'ASPIRATION	SAUGMOTOR	MOTOR ASPIRACION
3		R2841030	1	PIASTRA ASPIRATORE	PLAQUE	PLAQUE	BEFESTIGUNGSAUFLAGE	PLACA
4		M2360014	1	ANELLO CON GUARNIZIONE	RING WITH GASKET	ANNEAU AVEC JOINT	RING MIT DICHTUNG	ANILLO CON JUNTA
5		T4550007	1	TAPPO	PLUG	BOUCHON	DECKEL	TAPON
6		R2841020	1	TUBO INOX	PIPE	TUBE	ROHR	TUBO
7		E7510630	1	TUBO D.50	HOSE	TUYAU	SCHLAUCH	TUBO
8		R2841050	1	VASCETTA	BASIN	PETIT BASSIN	KLEINE WANNE	BANDEJA AGUA
9		T4220013	4	FASCETTA	CLAMP	COLLIER	LAGGERING	ANILLO
10		R1516060	3	COLONETTA M6x115	STUD BOLT	TIGE	GEWINDEBOLZEN	PRISIONERO
11		T2910001	3	PASSACAVO	FAIRLEAD	PASSE-CABLE	KABELMUFFE	GUIACABLE
12		E7530010	1	TUBO FONOASSORBENTE	DEADENING HOSE	TUYAU ISOLANT PHONIQUE	SCHALLSCHLUCKER	TUBO FONOABSORBENTE
13		E7401020	1	CUFFIA	GASKET	JOINT	LAGERRING	ANILLO
14		T1707112	2	SPAZZOLA MOTORE	CARBON BRUSH MOTOR	CHARBON MOTEUR	KOHLEBÜRSTE	ESCOBILLA MOTOR
15		T0800005	1	GUARNIZIONE OR	O-RING	JOINT	O-RING	JUNTA ANULAR
16		R2236020	1	TAPPO	PLUG	BOUCHON	DECKEL	TAPON
17		R2736030	1	CATENELLA	CHAIN	CHAINE	KETTE	CADENA
18		T4008005	1	POMELLO	KNOB	POMMEAU	RENDELSCHRAUBE	POMO
19		R2736010	1	TAPPO SCARICO	PLUG EXHAUST PIPE	BOUCHON DE VIDANGE	ABLASSPFROPFEN	TAPON ESCAPE
20		E7300080	1	MANICOTTO	COUPLING	MANCHON	MUFFE	MANGUITO
21		E7511030	1	TUBO D50x800	PIPE	TUBE	ROHR	TUBO
22		R2736060	1	CATENELLA	CHAIN	CHAINE	KETTE	CADENA
23		R2736070	1	AGGANCIO	COUPLER	CROCHET	ARRETIERUNG	GANCHO
24		T4540022	1	PORTAGOMMA 2"	CONNECTOR	RACCORD	SCHLAUCHANSCHLUSS	EMPALME TUBO DE GOMA
25		E7400110	1	GUARNIZIONE	GASKET	GARNITURE	DICHTUNG	JUNTA
26		R1336030	1	TAPPO	PLUG	BOUCHON	DECKEL	TAPON
27		E7400080	1	GUARNIZIONE	GASKET	GARNITURE	DICHTUNG	JUNTA
28		E7400070	1	GUARNIZIONE	GASKET	GARNITURE	DICHTUNG	JUNTA
29		T1502002	2	COPIGLIA Ø 2x20	SPLIT PIN	GOUPILLE	SPLINT	PASADOR DE ALETAS
30		R0341030	1	GALLEGGIANTE	FLOAT	FLOTTEUR	SCHWIMMER	FLOTADOR
31		E6500110	1	FILTRO	FILTER	FILTRE	FILTER	FILTRO
32		R1336010	1	PROTEZIONE	PROTECTION	PROTECTION	SCHUTZ	PROTECCION
33		M0140070	1	TUBO SCARICO COMPLETO	EXHAUST PIPE ASSEMBLY	FLEXIBLE DE VIDANGE COMP.	ABWASSERSCHLAUCH KOMPL.	TUBO DE ESCAPE COMPLETO
34		E9230070	1	MOLLA	SPRING	RESSORT	FEDER	RESORTE
35		T4220001	1	FASCETTA	CLAMP	COLLIER	BRIDE	ABRAZADERA
36		E7100210	1	FONOASSORBENTE	DEADENING	ISOLANT PHON	SCHALLSCHLUCKER	FONOABSORBENTE
37		E7100220	1	FONOASSORBENTE	DEADENING	ISOLANT PHON	SCHALLSCHLUCKER	FONOABSORBENTE
38		E7100200	1	FONOASSORBENTE	DEADENING	ISOLANT PHON	SCHALLSCHLUCKER	FONOABSORBENTE
39		E7510610	1	TUBO Ø 38	HOSE	TUYAU	SCHLAUCH	TUBO DE GOMA
40		R2846080	2	CERNIERA	HINGE	CHARNIERE	SCHARNER	BISAGRA
41		T4580001	1	GHIERA 2"	RING NUT	EMBOUT	NUTMUTTER	TUERCA ANULAR
42		R2736020	1	LAMA	BLADE	PLAQUETTE	LEISTE	LISTON
43		R1336090	1	ATTACCO	COUPLING	ATTAQUE	KUPPLUNG	ACOPLAMIENTO
44		R2441010	1	SEDE PORTAFILTRO	FILTER-HOLDER SEAT	SIEGE DU LE PORTE-FILTRE	SITZ VOM FILTERTRAEGE	PORTAFILTRO
45		M2410003	1	KIT PROTEZIONE + FILTRO	ASSEMBLY PROTECTION + FILTER	GROUPE DE PROTEC.+FILTRE	GRUPPE SCHUTZ + FILTER	GRUPO PROTECCION + FILTRO
46		M2410004	1	KIT TAPPO ASPIRAZIONE	ASSEMBLY SUCTION PLUG	GROUPE BOUCHON D'ASPIR.	GRUPPE ABSAUGDECKEL	GRUPO TAPON DE ASPIRACION
47		R1336020	1	ASTA CON PIATTELLO	ROD	PIVOT	STANGE	VARILLA
48		E7100190	1	FONOASSORBENTE	DEADENING	ISOLANT PHON	SCHALLSCHLUCKER	FONOABSORBENTE

Pos.	Mod.	Codice	Q.tà	Denominazione	Denomination	Description	Benennung	Descripcion
49	KLINIK	E7100170	1	FONOASSORBENTE	DEADENING	ISOLANT PHON	SCHALLSCHLUCKER	FONOABSORBENTE
50	KLINIK	E7100160	1	FONOASSORBENTE	DEADENING	ISOLANT PHON	SCHALLSCHLUCKER	FONOABSORBENTE
51		E7100140	1	FONOASSORBENTE	DEADENING	ISOLANT PHON	SCHALLSCHLUCKER	FONOABSORBENTE
52		E7100150	1	FONOASSORBENTE	DEADENING	ISOLANT PHON	SCHALLSCHLUCKER	FONOABSORBENTE
53		E7100180	1	FONOASSORBENTE	DEADENING	ISOLANT PHON	SCHALLSCHLUCKER	FONOABSORBENTE
54		E7520790	1	TUBO SPIRALATO	HOSE	TUYAU	SCHLAUCH	TUBO
55	KLINIK	R2841040	1	PIASTRA SUPPORTO MOTORE	PLATE	PLAQUE	TELLER	PLACA
56	KLINIK	M2810130	1	MOTORE ASPIRAZIONE	SUCTION MOTOR	MOTEUR D'ASPIRATION	SAUGMOTOR	MOTOR ASPIRACION
57	KLINIK	T1708121	2	SPAZZOLA MOTORE	CARBON BRUSH MOTOR	CHARBON MOTEUR	KOHLEBÜRSTE	ESCOBILLA MOTOR
59		-	-	DADO M8 UNI 5588 INOX	NUT	ECROU	MUTTER	TUERCA
60		-	-	VITE Ø 4.8x13 AUTOFIL.	SCREW	VIS	SCHRAUBE	TORNILLO
61		E6500440	1	FILTRO AIR STOP	FILTER	FILTRE	FILTER	FILTRO
62		T4220022	1	FASCETTA A SCATTO	CLAMP	COLLIER	BRIDE	ABRAZADERA
63		-	-	VITE M4x25 TE UNI 5739 INOX	SCREW	VIS	SCHRAUBE	TORNILLO
64		-	-	RONDELLA Ø 5x20 UNI 6593	WASHER	RONDELLE	UNTERLAGSCHEIBE	ARANDELA
65		-	-	DADO M4 UNI 5588 INOX	NUT	ECROU	MUTTER	TUERCA
66		-	-	RONDELLA Ø 4x9 NYLON	WASHER	RONDELLE	UNTERLAGSCHEIBE	ARANDELA
67		-	-	VITE M6x16 TE UNI 5739	SCREW	VIS	SCHRAUBE	TORNILLO
68		-	-	RONDELLA Ø 6	WASHER	RONDELLE	UNTERLAGSCHEIBE	ARANDELA
69		-	-	DADO M6 AUOTBL. UNI 7474	LOCK NUT	ECROU AUTOBLOQUANT	STOPMUTTER	TUERCA AUTOBLOCANTE
70		-	-	VITE M5x12 TE UNI 5739	SCREW	VIS	SCHRAUBE	TORNILLO
71		-	-	RONDELLA Ø 5 GROWER	WASHER	RONDELLE	UNTERLAGSCHEIBE	ARANDELA
72		-	-	RONDELLA Ø 5x10 UNI 6592	WASHER	RONDELLE	UNTERLAGSCHEIBE	ARANDELA
73		-	-	DADO M5 AUTOBL. UNI 7474	LOCK NUT	ECROU AUTOBLOQUANT	STOPMUTTER	TUERCA AUTOBLOCANTE
74		-	-	DADO M6 UNI 5588	NUT	ECROU	MUTTER	TUERCA
75		-	-	VITE TPSTC 4.5x16 AUTOF.	SCREW	VIS	SCHRAUBE	TORNILLO
76		-	-	GRANO M8x60 UNI 5963	DOWEL	VIS	MADENSCHRAUBE	TORNILLO
77		-	-	RONDELLA Ø 8x17 UNI 6592	WASHER	RONDELLE	UNTERLAGSCHEIBE	ARANDELA
78		-	-	VITE M8x35 TE UNI 5793	SCREW	VIS	SCHRAUBE	TORNILLO
79		-	-	VITE TCTC 4.2x16 UNI 6954	SCREW	VIS	SCHRAUBE	TORNILLO
80		-	-	VITE M6X20 TE UNI 5739 INOX	SCREW	VIS	SCHRAUBE	TORNILLO
81		-	-	RONDELLA Ø 6x18 INOX	WASHER	RONDELLE	UNTERLAGSCHEIBE	ARANDELA
82		-	-	DADO M6 AUTOBL. INOX	LOCK NUT	ECROU AUTOBLOQUANT	STOPMUTTER	TUERCA AUTOBLOCANTE
83		-	-	VITE TCTC M.5x16 UNI 7687	SCREW	VIS	SCHRAUBE	TORNILLO
84		-	-	VITE TCTC 4.8x13 UNI 6954	SCREW	VIS	SCHRAUBE	TORNILLO
85		R1336130	1	ATTACCO FILTRO	COUPLER	CROCHET	ARRETIERUNG	GANCHO
86		-	-	VITE TPSTC M5x25 UNI7689 A2	SCREW	VIS	SCHRAUBE	TORNILLO
87		M2410009	-					GRUPO TAPON DE
88		40741020	1	KIT TAPPO ASPIRAZIONE FASCETTA FISSA TUBO SCARICO	ASSEMBLY SUCTION PLUG WRAPPER FIXED UNLOADED PIPE	GRUPE BOUCHON D'ASPIR. BANDELETTE FIXE TUYAU DÉCHARGÉ	GRUPPE ABSAUGDECKEL ES BEFESTIGT BÄNDCHEN, ICH GURRE UNBELADEN	ASPIRACION FAJA FIJO TUBO DESCARGADO

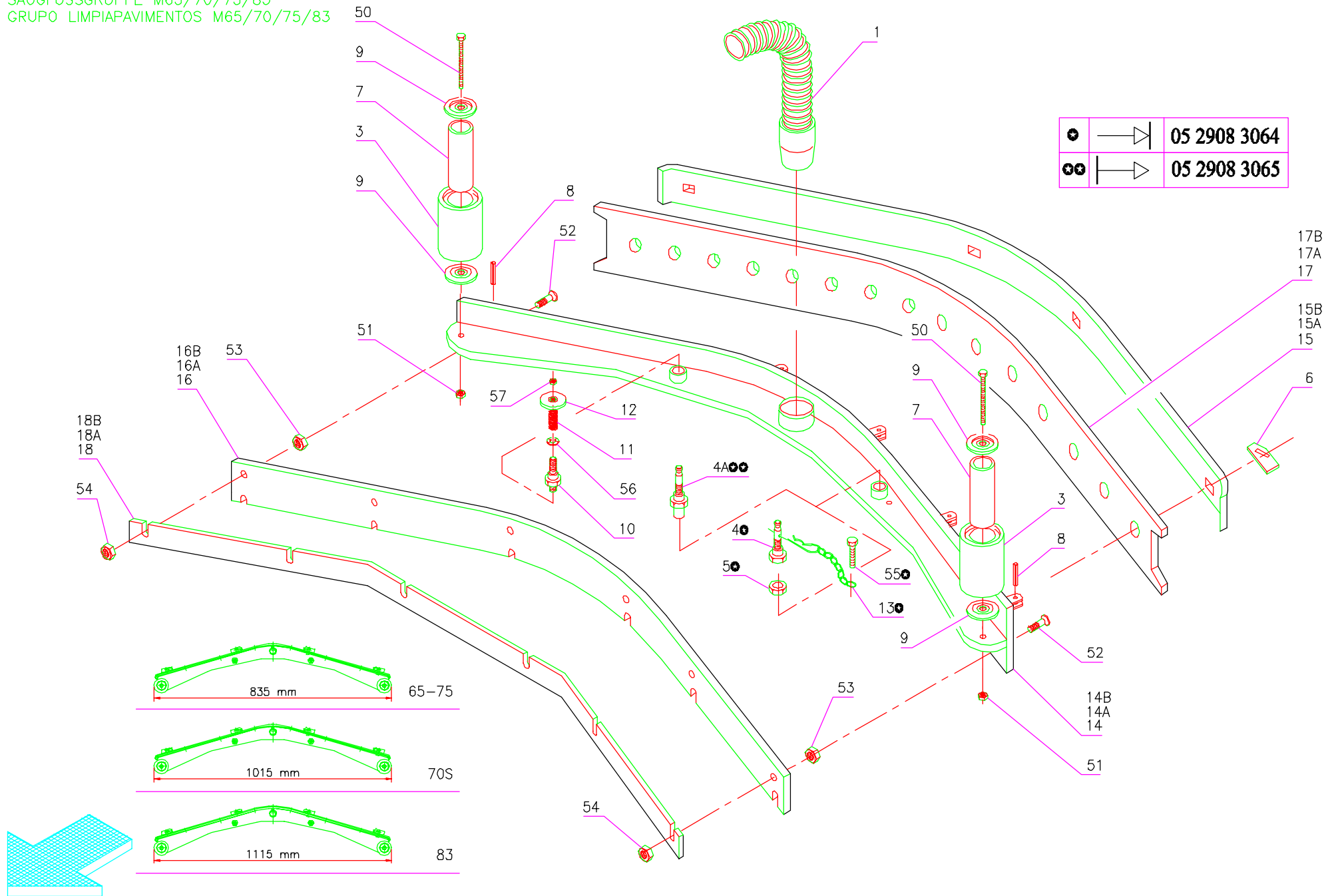

Pos.	Mod.	Codice	Q.tà	Denominazione	Denomination	Description	Benennung	Descripcion
1		E7510730	1	TUBO Ø 50x1550	HOSE	TUYAU	SCHLAUCH	TUBO
3		E7020110	2	RUOTA PARACOLPI	WHEEL	ROUE	RAD	RUEDA
4		R0111010	1	COLONNETTA	STUD BOLT	TIGE	GEWINDEBOLZEN	PRISIONERO
4A		R5811010	1	COLONNETTA	STUD BOLT	TIGE	GEWINDEBOLZEN	PRISIONERO
5		R0712010	1	DADO M12 SPECIALE	SPECIAL NUT	ECROU SPECIAL	SPEZIALMUTTER	TUERCA ESPECIAL
6		R1511060	4	PIASTRINA	PLAQUE	PLAQUETTE	BEFESTIGUNGSAUFLAGE	PLAQUETA
7		R1511090	2	TUBO GUIDA RUOTE	PIN	AXE	BOLZEN	PERNO
8		T1404004	4	SPINA ELASTICA Ø 4x14	SPRING PIN	FOURCHETTE	SPANNSTIFT	PASADOR
9		R1511080	4	RONDELLA SPECIALE	SPECIAL WASHER	RONDELLE SPECIALE	BESONDERESCHEIBE	ARANDELA ESPECIAL
10		R2811010	1	COLONNETTA M8	STUD BOLT	TIGE	GEWINDEBOLZEN	PRISIONERO
11		E9210340	1	MOLLA	SPRING	RESSORT	FEDER	RESORTE
12		R0812100	1	CONTRODADO M8	ADJUSTER NUT	ECROU DE REGLAGE	RÄNDELMUTTER	CONTRATUERCA
13		R1511100	1	CATENELLA CON SPILLO	CHAIN WITH PIN	CHAINE	KETTE MIT SPLINT	CADENA
14	65-75	E9628020	1	CORPO TERGIPAVIMENTO	SQUEEGEE BODY	CORPS DE SUCEUR	SAUGFUSSKÖRPER	CUERPO LIMPIADOR DE SUELO
14A	70S	E9629010	1	CORPO TERGIPAVIMENTO	SQUEEGEE BODY	CORPS DE SUCEUR	SAUGFUSSKÖRPER	CUERPO LIMPIADOR DE SUELO
14B	83	E9639010	1	CORPO TERGIPAVIMENTO	SQUEEGEE BODY	CORPS DE SUCEUR	SAUGFUSSKÖRPER	CUERPO LIMPIADOR DE SUELO
15	65-75	E8828080	1	LAMA PREMIGOMMA POST.	BLADE	PLAQUETTE	LEISTE	LISTON
15A	70S	R1511030	1	LAMA PREMIGOMMA POST.	BLADE	PLAQUETTE	LEISTE	LISTON
15B	83	R1811020	1	LAMA PREMIGOMMA POST.	BLADE	PLAQUETTE	LEISTE	LISTON
16	65-75	E7723010	1	GOMMA ANTERIORE	FRONT RUBBER	BAVETTE AVANT	VORDERER SAUGGUMMI	GOMA DELANTERA
16A	70S	E7715010	1	GOMMA ANTERIORE	FRONT RUBBER	BAVETTE AVANT	VORDERER SAUGGUMMI	GOMA DELANTERA
16B	83	E7718010	1	GOMMA ANTERIORE	FRONT RUBBER	BAVETTE AVANT	VORDERER SAUGGUMMI	GOMA DELANTERA
17	65-75	E7728010	1	GOMMA POSTERIORE	REAR RUBBER	BAVETTE ARRIERE	HINTERER SAUGGUMMI	GOMA TRASERA
17A	70S	E7715020	1	GOMMA POSTERIORE	REAR RUBBER	BAVETTE ARRIERE	HINTERER SAUGGUMMI	GOMA TRASERA
17B	83	E7718020	1	GOMMA POSTERIORE	REAR RUBBER	BAVETTE ARRIERE	HINTERER SAUGGUMMI	GOMA TRASERA
18	65-75	E8823010	1	LAMA PREMIGOMMA ANT.	BLADE	PLAQUETTE	LEISTE	LISTON
18A	70S	R1511020	1	LAMA PREMIGOMMA ANT.	BLADE	PLAQUETTE	LEISTE	LISTON
18B	83	R1811010	1	LAMA PREMIGOMMA ANT.	BLADE	PLAQUETTE	LEISTE	LISTON
50		-	-	VITE M10x110 TE UNI 5737	SCREW	VIS	SCHRAUBE	TORNILLO
51		-	-	DADO M10 AUTOBL. UNI 5589	LOCK NUT	ECROU AUTOBLOQUANT	STOPMUTTER	TUERCA AUTOBLOCANTE
52		-	-	VITE M6x25 TPSEI UNI 5933 INOX	SCREW	VIS	SCHRAUBE	TORNILLO
53		-	-	DADO M6 UNI 5589 INOX	NUT	ECROU	MUTTER	TUERCA
54		-	-	DADO M6 AUTOBL. INOX	LOCK NUT	ECROU AUTOBLOQUANT	STOPMUTTER	TUERCA AUTOBLOCANTE
55		-	-	VITE M5x10 TCTC UNI 7687 INOX	SCREW	VIS	SCHRAUBE	TORNILLO
56		-	-	RONDELLA Ø 8x24 INOX	WASHER	RONDELLE	UNTERLAGSCHEIBE	ARANDELA
57		-	-	DADO M8 AUTOBL. UNI 5589	LOCK NUT	ECROU AUTOBLOQUANT	STOPMUTTER	TUERCA AUTOBLOCANTE
✱	65-75	M2110027	-	TERGIPAVIMENTO COMPLETO	SQUEEGEE ASSEMBLY	SUCEUR COMPLETO	SAUGFUSS KOMPLETT	LIMPIADOR COMPL.
✱	70S	M2110023	-	TERGIPAVIMENTO COMPLETO	SQUEEGEE ASSEMBLY	SUCEUR COMPLETO	SAUGFUSS KOMPLETT	LIMPIADOR COMPL.
✱	83	M2110031	-	TERGIPAVIMENTO COMPLETO	SQUEEGEE ASSEMBLY	SUCEUR COMPLETO	SAUGFUSS KOMPLETT	LIMPIADOR COMPL.
✱✱	65-75	M2110043	-	TERGIPAVIMENTO COMPLETO	SQUEEGEE ASSEMBLY	SUCEUR COMPLETO	SAUGFUSS KOMPLETT	LIMPIADOR COMPL.
✱✱	70S	M2110042	-	TERGIPAVIMENTO COMPLETO	SQUEEGEE ASSEMBLY	SUCEUR COMPLETO	SAUGFUSS KOMPLETT	LIMPIADOR COMPL.
✱✱	83	M2110044	-	TERGIPAVIMENTO COMPLETO	SQUEEGEE ASSEMBLY	SUCEUR COMPLETO	SAUGFUSS KOMPLETT	LIMPIADOR COMPL.

GRUPPO COMANDO TERGIPAVIMENTO M65/70/75/83
SQUEEGE CONTROL ASSEMBLY M65/70/75/83
COMMANDE DE SUCEUR M65/70/75/83
SAUGFUSSBEAETIGUNG M65/70/75/83
MANDO LIMPIAPAVIMENTOS M65/70/75/83

05 2908 3065

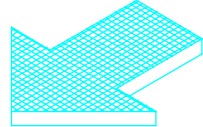
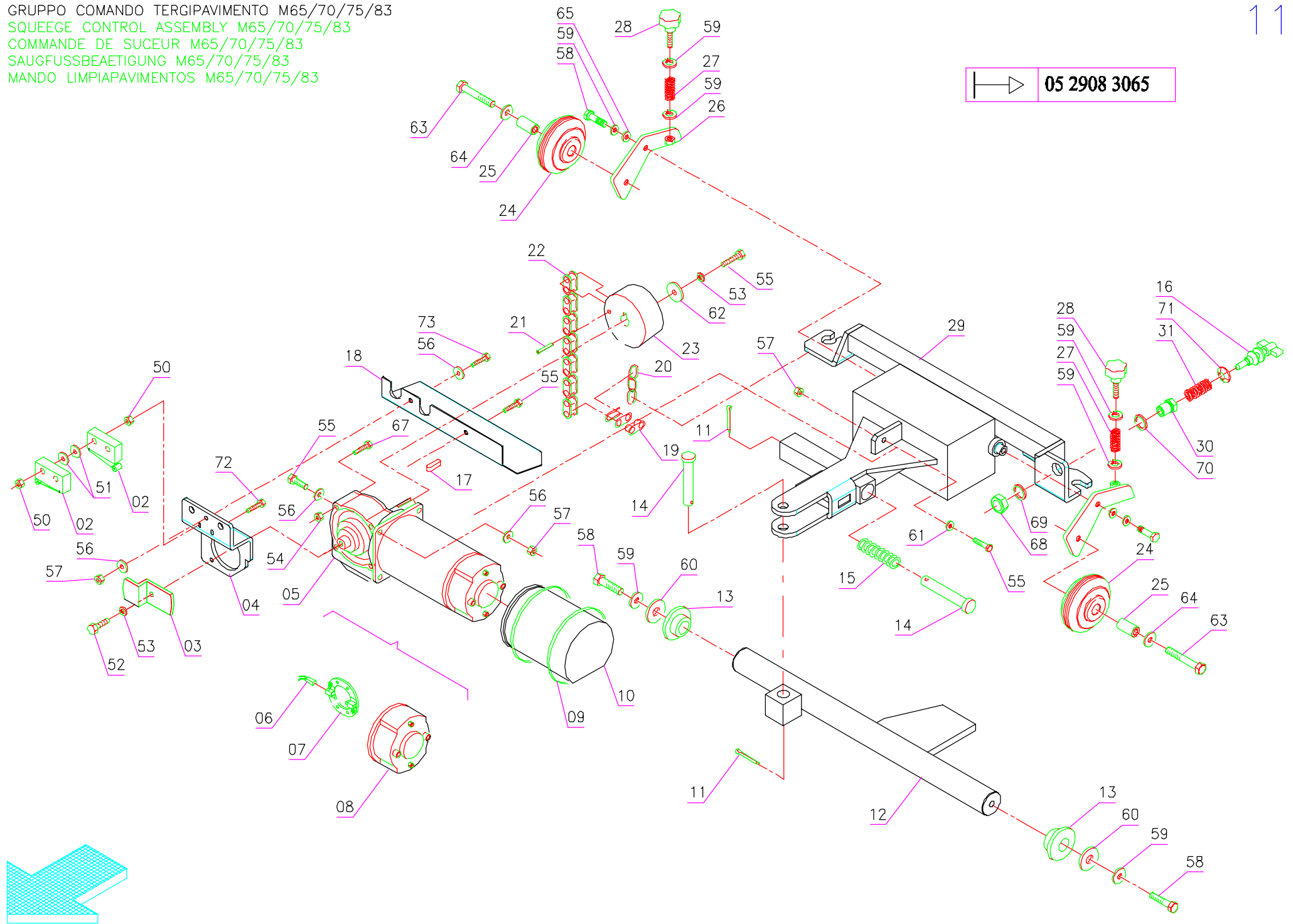

Pos.	Mod.	Codice	Q.tà	Denominazione	Denomination	Description	Benennung	Descripcion
02		T2105001	2	MICROINTERRUTTORE	MICROSWITCH	MICROINTERRUPTEUR	MIKROSHALTER	MICROINTERRUPTOR
03		R2711080	1	LEVA	LEVER	LEVIER	HEBEL	PALANCA
04		42212470	1	STAFFA	SUPPORT	ATTAQUE	HALTERUNG	SOPORTE FIJADOR
05		E8230350	1	MOTORIDUTTORE	GEARED MOTOR	MOTO-REDUCTEUR	GETRIEBEMOTOR	MOTORREDUCTOR
06		T1706092	2	SPAZZOLA MOTORE	CARBON BRUSH MOTOR	CHARBON MOTEUR	KOHLEBÜRSTE	ESCOBILLA MOTOR
07		T1700016	1	ANELLO PORTA SPAZZOLE	CARBON BRUSH HOLDER	PORTE-CHARBON	KOHLEBÜRSTENHALTERUNG	PORTAESCOBILLAS
08		T1700019	1	CALOTTA SPAZZOLE COMPLETA	CARBON BRUSH HOLDER	PORTE-CHARBON	KOHLEBÜRSTENHALTERUNG	PORTAESCOBILLAS
09		T4220001	2	FASCETTA PVC	CLAMP	COLLIER	BRIDE	ABRAZADERA
10		E7401030	1	CUFFIA MOTORE	SHROUD	JOINT	SAUGMOTORABDECKUNG	ANILLO DEL MOTOR
11		T1502002	3	COPIGLIA Ø 2X20 INOX	SPLIT PIN	GOUPILLE	SPLINT	PASADOR DE ALETAS
12		42212570	1	ALBERO	SHAFT	ARBRE	LENKWELLE	EJE
13		E9118010	2	BOCCOLA	BUSHING	BAGUE	BUCHSE	CASQUILLO
14		R2812030	1	PERNO	PIN	AXE	BOLZEN	PERNO
15		E9210310	1	MOLLA	SPRING	RESSORT	FEDER	RESORTE
16		R5812120	1	REGISTRO INCLINAZIONE	ADJUSTER	REGLAGE	VERSTELLSCHRAUBE	REGULADOR
17		T0405051	1	LINGUETTA 5x5x20	TONGUE	LANGUETTE	PASSFEDER	TONGUE
18		42216120	1	CARTER PROTEZIONE MOTORID	PROTECTION	PROTECTION	ABDECKUNG	PROTECCION
19		T0300002	1	GIUNZIONE CATENA	JOINT CHAIN	ATTACHE RAPID CHAINE	KETTENSCHLOSS	ESLABON
20		R2811030	1	CATENELLA	CHAIN	CHAINE	KETTE	CADENA
21		T1404007	1	SPINA ELASTICA Ø 4x36	SPRING PIN	FOURCHETTE	SPANNSTIFT	PASADOR
22		T0300011	1	CATENA	CHAIN	CHAINE	KETTE	CADENA
23		R2711070	1	RULLO	ROLLER	GALET	ROLLE	RODILLO
24		E7010220	2	RUOTA	WHEEL	ROUE	RAD	RUEDA
25		69104070	2	BOCCOLA	BUSHING	BAGUE	BUCHSE	CASQUILLO
26		R2811020	2	STAFFA	SUPPORT	ATTAQUE	HALTERUNG	SOPORTE FIJADOR
27		E9210320	2	MOLLA	SPRING	RESSORT	FEDER	RESORTE
28		T4008013	2	POMELLO	KNOB	POMMEAU	RENDELSCHRAUBE	POMO
29		42212560	1	BRACCIO	ARM	BRAS	ARM	BRAZO
30		R5812130	1	BOCCOLA	BUSHING	BAGUE	BUCHSE	CASQUILLO
31		E9210370	1	MOLLA	SPRING	RESSORT	FEDER	RESORTE
50		-	-	DADO M4 UNI5588	NUT	ECROU	MUTTER	TUERCA
51		-	-	ROSETTA M5 UNI6592	WASHER	RONDELLE	SCHEIBE	ARANDELA
52		-	-	VITE TE M6x16 UNI5739	SCREW	VIS	SCHRAUBE	TORNILLO
53		-	-	ROSETTA M6 UNI8839	LOCK WASHER	RONDELLE	ZAHNSCHEIBE	ARANDELA DENTADA
54		-	-	DADO AUTOBL. M5 UNI7473	LOCK NUT	ECROU AUTOBLOQUANT	STOPMUTTER	TUERCA AUTOBLOCANTE
55		-	-	VITE TE M6x20 UNI5939	SCREW	VIS	SCHRAUBE	TORNILLO
56		-	-	ROSETTA M6 UNI6592	WASHER	RONDELLE	SCHEIBE	ARANDELA
57		-	-	DADO AUTOBL. M6 UNI7474	LOCK NUT	ECROU AUTOBLOQUANT	STOPMUTTER	TUERCA AUTOBLOCANTE
58		-	-	VITE TE M8x16 UNI5739	SCREW	VIS	SCHRAUBE	TORNILLO
59		-	-	ROSETTA M8 UNI8839	LOCK WASHER	RONDELLE	ZAHNSCHEIBE	ARANDELA DENTADA
60		-	-	ROSETTA M8 D.32 UNI6593	WASHER	RONDELLE	SCHEIBE	ARANDELA
61		-	-	ROSETTA M6 D.18 UNI6593	WASHER	RONDELLE	SCHEIBE	ARANDELA
62		-	-	ROSETTA M6 D.24 UNI6593 (A2)	WASHER	RONDELLE	SCHEIBE	ARANDELA
63		-	-	VITE TE M10x60 UNI5737	SCREW	VIS	SCHRAUBE	TORNILLO
64		-	-	ROSETTA M10 UNI6592	WASHER	RONDELLE	SCHEIBE	ARANDELA
65		-	-	ROSETTA M8 D.24 UNI6593	WASHER	RONDELLE	SCHEIBE	ARANDELA
66		-	-	DADO M10 UNI5588 (A2)	NUT	ECROU	MUTTER	TUERCA
67		-	-	VITE TE M5x50 UNI5739	SCREW	VIS	SCHRAUBE	TORNILLO
68		-	-	DADO M16x1.5 UNI5589	NUT	ECROU	MUTTER	TUERCA
69		-	-	ROSETTA M16 SCHNORR	LOCK WASHER	RONDELLE	ZAHNSCHEIBE	ARANDELA DENTADA

Pos.	Mod.	Codice	Q.tà	Denominazione	Denomination	Description	Benennung	Descripcion
70	-	-	-	ROSETTA M16 D.24.5 UNI6592	WASHER	RONDELLE	SCHEIBE	ARANDELA
71	-	-	-	ROSETTA M12 SCHNORR	LOCK WASHER	RONDELLE	ZAHNSCHEIBE	ARANDELA DENTADA
72	-	-	-	VITE TE M4x55 UNI5739 A2	SCREW	VIS	SCHRAUBE	TORNILLO
73	-	-	-	VITE TE M6x25 UNI5739	SCREW	VIS	SCHRAUBE	TORNILLO

GRUPPO COMANDO TERGIPAVIMENTO M65/70/75/83
SQUEEGE CONTROL ASSEMBLY M65/70/75/83
COMMANDE DE SUCEUR M65/70/75/83
SAUGFUSSBEAETIGUNG M65/70/75/83
MANDO LIMPIAPAVIMENTOS M65/70/75/83

11A

05 2908 3064

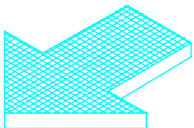
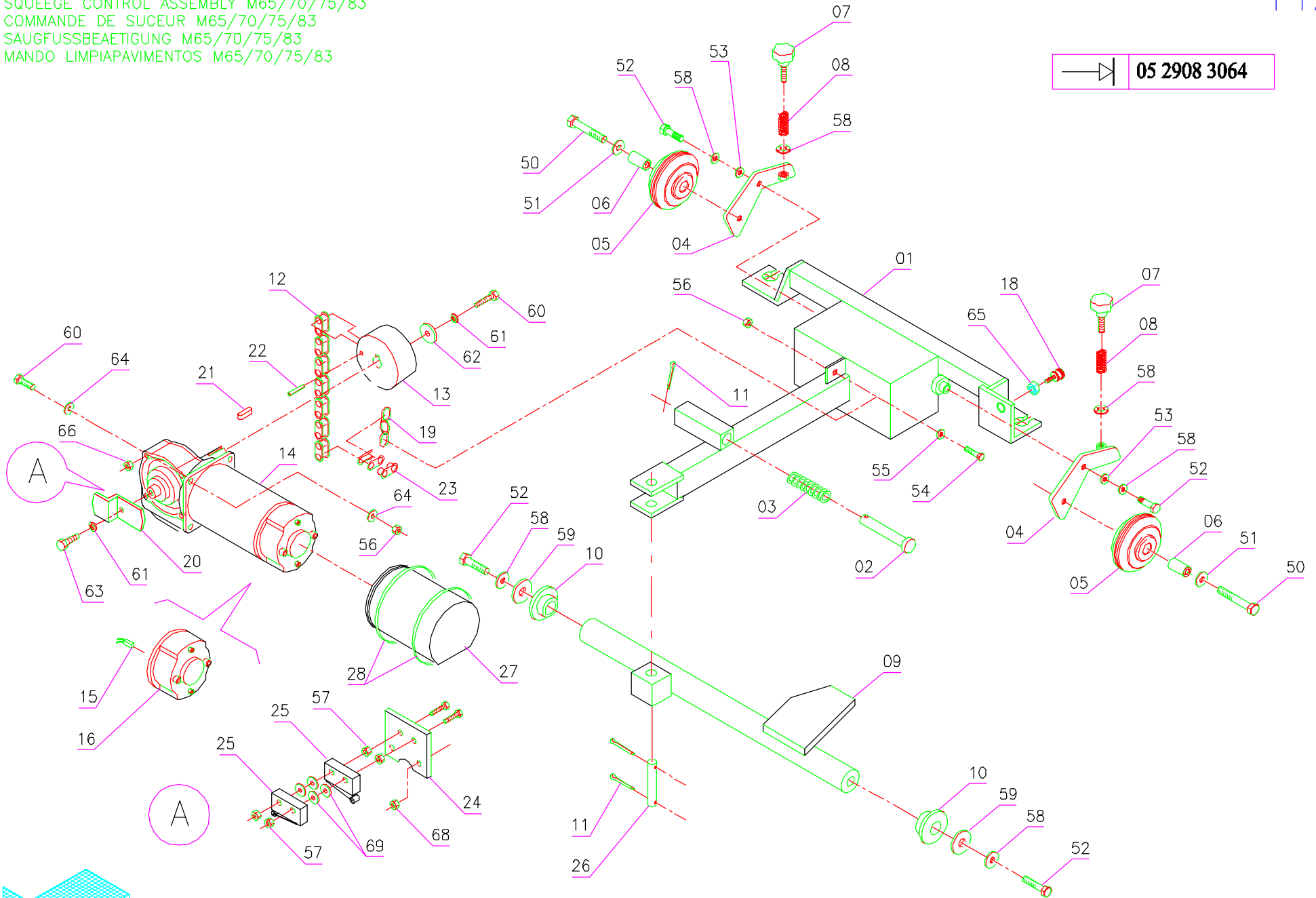

Pos.	Mod.	Codice	Q.tà	Denominazione	Denomination	Description	Benennung	Descripcion
1		R2812020	1	BRACCIO	ARM	BRAS	ARM	BRAZO
2		R2812030	1	PERNO	PIN	AXE	BOLZEN	PERNO
3		E9210310	1	MOLLA	SPRING	RESSORT	FEDER	RESORTE
4		R2811020	2	STAFFA	SUPPORT	ATTAQUE	HALTERUNG	SOPORTE FIJADOR
5		E7010220	2	RUOTA	WHEEL	ROUE	RAD	RUEDA
6		69104070	2	BOCCOLA	BUSHING	BAGUE	BUCHSE	CASQUILLO
7		T4008013	2	POMELLO	KNOB	POMMEAU	RENDELSCHRAUBE	POMO
8		E9210320	2	MOLLA	SPRING	RESSORT	FEDER	RESORTE
9		R2812010	1	ALBERO	SHAFT	ARBRE	LENKWELLE	EJE
10		E9118010	2	BOCCOLA	BUSHING	BAGUE	BUCHSE	CASQUILLO
11		T1502002	3	COPIGLIA Ø 2X20 INOX	SPLIT PIN	GOUPILLE	SPLINT	PASADOR DE ALETAS
12		T0300011	1	CATENA	CHAIN	CHAINE	KETTE	CADENA
13		R2711070	1	RULLO	ROLLER	GALET	ROLLE	RODILLO
14		E8230350	1	MOTORIDUTTORE	GEARED MOTOR	MOTO-REDUCTEUR	GETRIEBEMOTOR	MOTORREDUCTOR
15		T1706092	2	SPAZZOLA MOTORE	CARBON BRUSH MOTOR	CHARBON MOTEUR	KOHLEBÜRSTE	ESCOBILLA MOTOR
16		T1700019	1	CALOTTA SPAZZOLE COMPLETA	CARBON BRUSH HOLDER	PORTE-CHARBON	KOHLEBÜRSTENHALTERUNG	PORTAESCOBILLAS
18		R0112120	1	REGISTRO INCLINAZIONE	ADJUSTER	REGISTRE	REGISTER	REGULADOR
19		R2811030	1	CATENELLA	CHAIN	CHAINE	KETTE	CADENA
20		R2711080	1	LEVA	LEVER	LEVIER	HEBEL	PALANCA
21		T0405051	1	LINGUETTA 5x5x20	TONGUE	LANGUETTE	PASSFEDER	TONGUE
22		T1404007	1	SPINA ELASTICA Ø 4x36	SPRING PIN	FOURCHETTE	SPANNSTIFT	PASADOR
23		T0300002	1	GIUNZIONE CATENA	JOINT CHAIN	ATTACHE RAPID CHAINE	KETTENSCHLOSS	ESLABON
24		R2812050	1	STAFFA	SUPPORT	ATTAQUE	HALTERUNG	SOPORTE FIJADOR
25		T2105001	2	MICROINTERRUTTORE	MICROSWITCH	MICROINTERRUPTEUR	MIKROSHALTER	MICROINTERRUPTOR
26		R2812040	1	PERNO	PIN	AXE	BOLZEN	PERNO
27		E7401030	1	CUFFIA MOTORE	SHROUD	JOINT	SAUGMOTORABDECKUNG	ANILLO DEL MOTOR
28		T4220001	2	FASCETTA PVC	CLAMP	COLLIER	BRIDE	ABRAZADERA
50				VITE M10x60 TE UNI 5737	SCREW	VIS	SCHRAUBE	TORNILLO
51				RONDELLA Ø 10x21 UNI 6592	WASHER	RONDELLE	UNTERLAGSCHEIBE	ARANDELA
52				VITE M8x16 TE UNI 5739	SCREW	VIS	SCHRAUBE	TORNILLO
53				RONDELLA Ø 8x24 UNI 6593	WASHER	RONDELLE	UNTERLAGSCHEIBE	ARANDELA
54				VITE M6x20 TE UNI 5739	SCREW	VIS	SCHRAUBE	TORNILLO
55				RONDELLA Ø 6x18 UNI 6593	WASHER	RONDELLE	UNTERLAGSCHEIBE	ARANDELA
56				DADO M6 AUTOBL. UNI 7474	LOCK NUT	ECROU AUTOBLOQUANT	STOPMUTTER	TUERCA AUTOBLOCANTE
57				DADO M4 UNI 5588	NUT	ECROU	MUTTER	TUERCA
58				RONDELLA Ø 8 GROWER	WASHER	RONDELLE	UNTERLAGSCHEIBE	ARANDELA
59				RONDELLA Ø 8x32 UNI 6593	WASHER	RONDELLE	UNTERLAGSCHEIBE	ARANDELA
60				VITE M6x20 TE UNI 5739	SCREW	VIS	SCHRAUBE	TORNILLO
61				RONDELLA Ø 6 GROWER	WASHER	RONDELLE	UNTERLAGSCHEIBE	ARANDELA
62				RONDELLA Ø 6x24 INOX	WASHER	RONDELLE	UNTERLAGSCHEIBE	ARANDELA
63				VITE M6x16 TE UNI 5739	SCREW	VIS	SCHRAUBE	TORNILLO
64				RONDELLA Ø 6x12 UNI 6592	WASHER	RONDELLE	UNTERLAGSCHEIBE	ARANDELA
65				DADO M10 UNI 5588 INOX	NUT	ECROU	MUTTER	TUERCA
66				DADO M5 UNI 5588	NUT	ECROU	MUTTER	TUERCA
67				VITE M4x50 TE UNI 5739	SCREW	VIS	SCHRAUBE	TORNILLO
68				DADO M5 AUTOBL. UNI 7474	LOCK NUT	ECROU AUTOBLOQUANT	STOPMUTTER	TUERCA AUTOBLOCANTE
69				RONDELLA Ø 5x10 UNI 6592	WASHER	RONDELLE	UNTERLAGSCHEIBE	ARANDELA

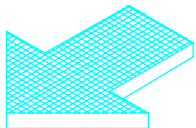
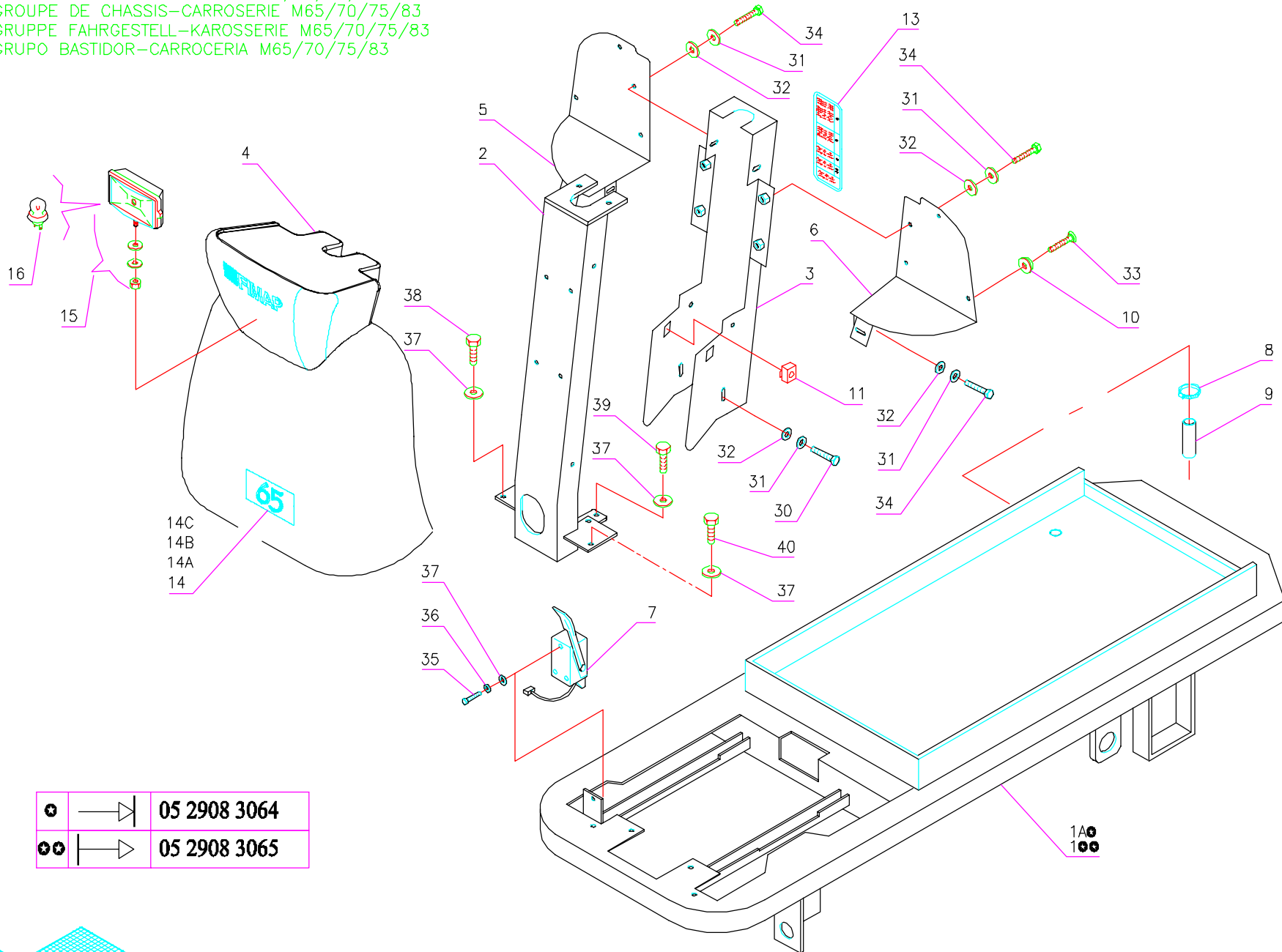

Pos.	Mod.	Codice	Q.tà	Denominazione	Denomination	Description	Benennung	Descripcion
1		69922700	1	TELAIO	FRAME	CHASSIS	FAHRGESTELL	BASTIDOR
1A		E9928100	1	TELAIO	FRAME	CHASSIS	FAHRGESTELL	BASTIDOR
2		E9928200	1	TELAIO ANTERIORE	FRAME, FRONT	CHASSIS AVANT	FAHRGESTELL, VORDERE	BASTIDOR ANTERIOR
3		R2846040	1	CARTER	COVER	CARTER	ABDECKUNG	CARTER
4		R2846010	1	MUSETTO	NOSE	FRONTAL	STIRNBRETT	FRONTAL
5		R2846140	1	PANNELLO DX	RIGHT FENDER	GARDE-BOUE DROITE	ABDECKUNG RECHTS	GUARDABARROS DERECHO
6		R2846060	1	PANNELLO SX	LEFT FENDER	GARDE-BOUE GAUCHE	ABDECKUNG LINKS	GUARDABARROS IZQUIERDO
7		T4802015	1	PEDALE	PEDAL	PEDALE	PEDAL	PEDAL
8		T4220002	1	FASCETTA	CLAMP	COLLIER	BRIDE	ABRAZADERA
9		E7521090	1	TUBO Ø 10x350	HOSE	TUYAU	SCHLAUCH	TUBO DE GOMA
10		R1316010	6	RONDELLA SPECIALE	SPECIAL WASHER	RONDELLE SPECIALE	UNTERLAGSCHEIBE SPEZIAL	ARANDELA ESPECIAL
11		T1050601	2	DADO M6 A GABBIA	NUT	ECROU	MUTTER	TUERCA
13		E6410311	1	KIT ETICHETTE	DECAL	ETIQUETTE	SCHILD	ETIQUETA
14	65	E6410305	1	ETICHETTA	DECAL	ETIQUETTE	SCHILD	ETIQUETA
14A	70S	E6410306	1	ETICHETTA	DECAL	ETIQUETTE	SCHILD	ETIQUETA
14B	75	E6410307	1	ETICHETTA	DECAL	ETIQUETTE	SCHILD	ETIQUETA
14C	83	E6410353	1	ETICHETTA	DECAL	ETIQUETTE	SCHILD	ETIQUETA
15	INDY	T2300213	1	FARO (SENZA LAMPADA)	HEAD LIGHT (WITHOUT BULB)	PROJECTEUR (SANS AMPOULE)	ARBEITSLICHT (OHNE LAMPE)	FARO (SIN LAMPARA)
16	INDY	T2300001	1	LAMPADA 24V 70W	ELECTRIC BULB	AMPOULE	GLÜHLAMPE	LAMPARA
30		-	-	VITE M6x20 TE UNI 5739	SCREW	VIS	SCHRAUBE	TORNILLO
31		-	-	RONDELLA Ø 6 GROWER	LOCK WASHER	RONDELLE FREIN	ZAHNSCHEIBE	ARANDELLA DENTADA
32		-	-	RONDELLA Ø 6x12 UNI 6592	WASHER	RONDELLE	UNTERLAGSCHEIBE	ARANDELA
33		-	-	VITE M5x16 TPSTC UNI 7688	SCREW	VIS	SCHRAUBE	TORNILLO
34		-	-	VITE M6x16 TE UNI 5739	SCREW	VIS	SCHRAUBE	TORNILLO
35		-	-	VITE M8x16 UNI 5739	SCREW	VIS	SCHRAUBE	TORNILLO
36		-	-	RONDELLA Ø 8 GROWER	LOCK WASHER	RONDELLE FREIN	ZAHNSCHEIBE	ARANDELLA DENTADA
37		-	-	RONDELLA Ø 8x17 UNI 6592	WASHER	RONDELLE	UNTERLAGSCHEIBE	ARANDELA
38		-	-	VITE M8x60 TE UNI 5739	SCREW	VIS	SCHRAUBE	TORNILLO
39		-	-	VITE M8x20 TE UNI 5739	SCREW	VIS	SCHRAUBE	TORNILLO
40		-	-	VITE M8x25 TE UNI 5739	SCREW	VIS	SCHRAUBE	TORNILLO

COMPONENTI ELETTRICI M65/70/75/83
 ELECTRIC COMPONENTS M65/70/75/83
 COMPOSANTS ELECTRIQUES M65/70/75/83
 ELEKTROTEILE M65/70/75/83
 COMPONENTES ELECTRICOS M65/70/75/83

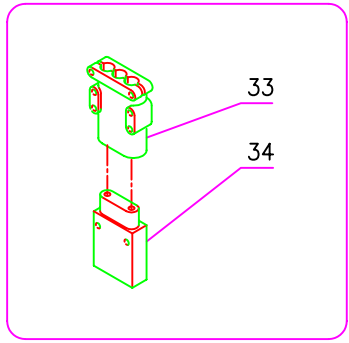
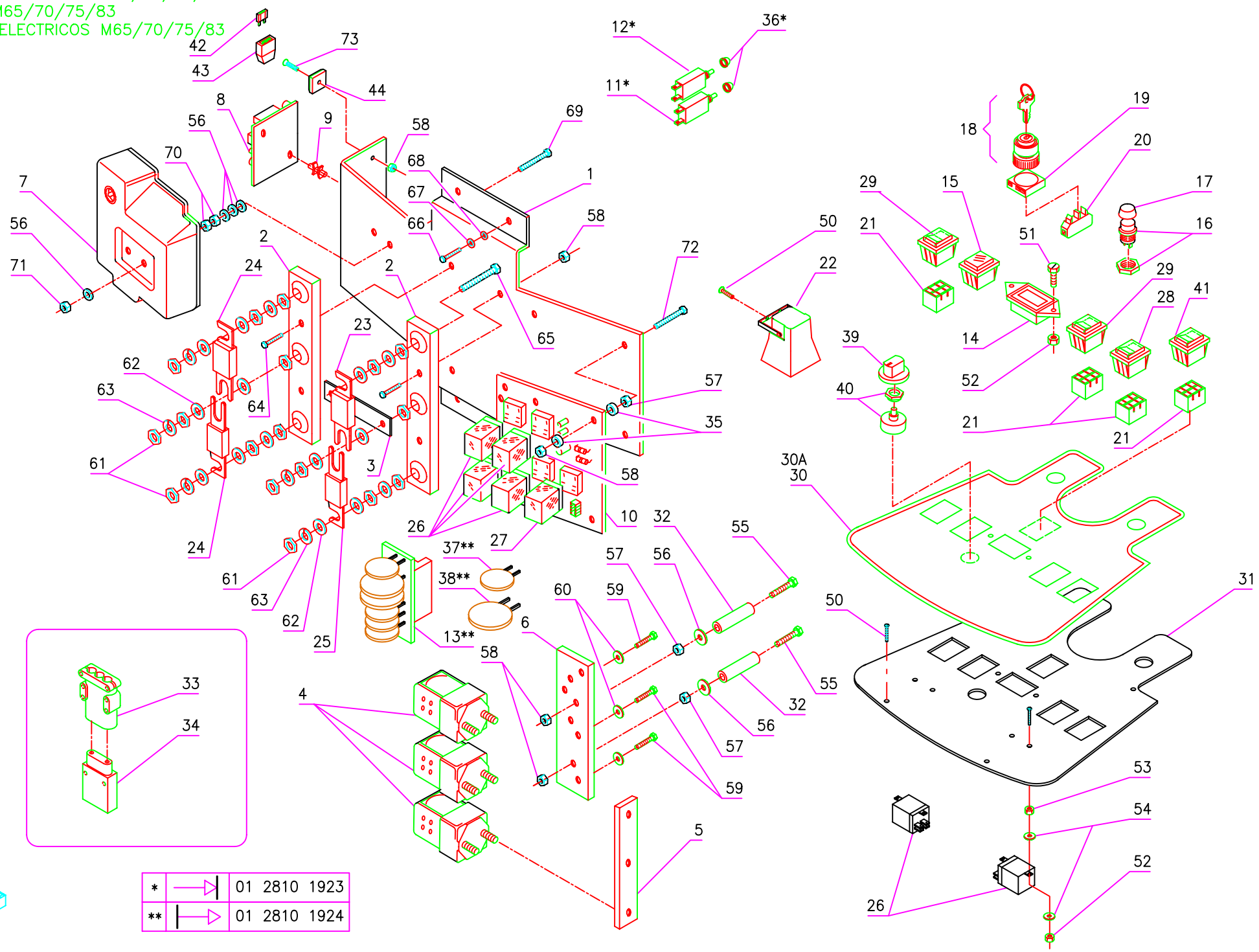

*		01 2810 1923
**		01 2810 1924

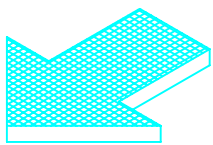

Pos.	Mod.	Codice	Q.tà	Denominazione	Denomination	Description	Benennung	Descripcion
1		R2851030	1	PANNELLO	PANEL	PANNEAU	BLECH	PANEL
2		T2400018	2	PORTAFUSIBILE	FUSEHOLDER	PORTE-FUSIBLE	SICHERUNGSHALTER	PORTAFUSIBLE
3		R1551030	1	PONTE FUSIBILI	BRIDGE	PONTAGE	VERBINDUNGSBRÜCKE	PUENTE
4		E8430001	3	TELERUTTORE 36V	REMOTE CONTROL SWITCH	TELERUPTEUR	SCHÜTZ	TELEINTERRUPTOR
5		R1551050	1	PONTE TELERUTTORI	BRIDGE	PONTAGE	VERBINDUNGSBRÜCKE	PUENTE
6		R2851020	1	STAFFA TELERUTTORI	SUPPORT	ATTAQUE	HALTERUNG	SOPORTE FIJADOR
7		E7900002	1	SCHEDA CHOPPER 36V	CHOPPER CARD	VARIATEUR ELECTRONIQUE	ELEKTRONIKKARTE	FICHA CHOPPER
8		E7900029	1	SCHEDA LIVELLO BATTERIA	CHECK CARD BATTERIES	PLAQUE CONTROLE BATT.	KONTROLLEL. BATTERIEN	FICHA CONTROL BATTERIAS
9		T2903001	2	AGGANCIO RAPIDO	COUPLER	ACCROCHAGE	SCHNELLVERSCHLUSS	ENGANCHE
10		E7900034	1	SCHEDA COMANDI	CHECK CARD CONTROLS	PLAQUE CONTR. COMM.	KONTROLLEL. SCHALTUNGEN	FICHA CONTROL MANDOS
11		T2106001	3	DISGIUNTORE DI SICUR. 8A	SAFETY SWITCH	INTERRUP. DE PROTECTION	SICHERHEITSCHALTER	INTERRUPTOR DE SEGURIDAD
12		T2106003	3	DISGIUNTORE DI SICUR. 3.5A	SAFETY SWITCH	INTERRUP. DE PROTECTION	SICHERHEITSCHALTER	INTERRUPTOR DE SEGURIDAD
13		E7900035	1	SCHEDA FUSIBILI	CHECK CARD FUSES	PLAQUE CONTROLE FUSIBLES	KONTROLLKARTE SICHERUNGEN	FICHA CONTROL FUSIBLES
14		T2904004	1	CONTAORE	HOUR METER	COMPTEUR HORAIRE	BETRIEBSSTUNDENZÄHLER	CUENTAHORAS
15		T2300130	1	DISPLAY LIVELLO BATTERIE	BATTERY WARNING LIGHT	TEMOIN DE BATTERIES	BATTERIESIGNAL	SEÑAL BATERIAS
16		T2199006	1	INTERRUPTORE	SWITCH	INTERRUPTEUR	SCHALTER	INTERRUPTOR
17		T4806008	1	CAPPUCCIO	PROTECTION CAP	CALOTTE DE PROTECTION	SICHERHEITKAPPE	CAPUCHO
18		T2199014	1	INTERRUPTORE	SWITCH	INTERRUPTEUR	SCHALTER	INTERRUPTOR
19		T2199015	1	FLANGIA	FLANGE	FLASQUE	FLANSH	BRIDA
20		T2107005	1	CONTATTO	CONTACT	CONTACT	KONTAKT	CONTACTO
21		T2908003	3	ZOCCOLO POLARIZZATO	POLARIZED BASE	POLARISEE' SOUBASSEMENT	POLARISIERTER SOCKEL	BASE-POLARIZADA
22		T2905011	1	CICALINO	BUZZER	RONFLEUR	SUMMER	AVISADOR ACUSTICO
23		T2403501	1	FUSIBILE LAMELLARE 35A	FUSE	FUSIBLE	SICHERUNG	FUSIBLE
24		T2408001	2	FUSIBILE LAMELLARE 80A	FUSE	FUSIBLE	SICHERUNG	FUSIBLE
25		T2416001	1	FUSIBILE LAMELLARE 160A	FUSE	FUSIBLE	SICHERUNG	FUSIBLE
26		E8399020	6	RELE' 24V 20A	RELAY	RALAIS	RELAIS	RELE
27		E8399010	1	RELE' 24V 30A	RELAY	RALAIS	RELAIS	RELE
28		T2101003	1	DEVIATORE	SWITCH	INTERRUPTEUR	SCHALTER	DESVIADOR
29		T2101009	2	COMMUTATORE BIPOL. GIALLO	COMMUTATOR	COMMUTATEUR	SCHALTUNG	CONMUTADOR
30	*	E6410360	1	ETICHETTA CRUSCOTTO	DECAL	ETIQUETTE	SCHILD	ETIQUETA
30A	BASIC	E6410361	1	ETICHETTA CRUSCOTTO	DECAL	ETIQUETTE	SCHILD	ETIQUETA
31		R2846130	1	LAMIERA CRUSCOTTO	INSTRUMENT BOARD	TABLEAU DE BORD	ARMATURENBRETT	TABLERO DE INSTRUMENTOS
32		E9113050	2	BOCCOLA	BUSHING	BAGUE	BUCHSE	CASQUILLO
33		E8000690	1	SPINA 80A	CONNECTOR MALE	CONNECTEUR MALE	STECKER MIT ZAPFEN	CONNECTADOR
34		E8000700	1	PRESA 80A	CONNECTOR FEMALE	CONNECTEUR FEMELLE	STECHER OHNE ZAPFEN	CONNECTADOR
35		T1104003	8	RONDELLA Ø 4x8x3 NYLON	WASHER	RONDELLE	UNTERLAGSCHEIBE	ARANDELA
36		T2903003	6	CAPPUCCIO DISGIUNTORE	PROTECTION CAP	CALOTTE DE PROTECTION	SICHERHEITKAPPE	CAPUCHO
37		T2106005	-	DISGIUNTORE DI SICUR. 2A	SAFETY SWITCH	INTERRUP. DE PROTECTION	SICHERHEITSCHALTER	INTERRUPTOR DE SEGURIDAD
38		T2106006	-	DISGIUNTORE DI SICUR. 3.5A	SAFETY SWITCH	INTERRUP. DE PROTECTION	SICHERHEITSCHALTER	INTERRUPTOR DE SEGURIDAD
39	*	T4100012	1	MANOPOLA	KNOB	POIGNEE	DREHGRIF	EMPUÑADURA
40	*	E8303010	1	COMMUTATORE 3 POSIZIONI	COMMUTATOR	COMMUTATEUR	SCHALTUNG	CONMUTADOR
41	INDY	T2102001	1	INTERRUPTORE LUMIN. VERDE	SWITCH	INTERRUPTEUR	SCHALTER	INTERRUPTOR
42	INDY	T2401001	1	FUSIBILE 10A	FUSE	FUSIBLE	SICHERUNG	FUSIBLE
43	INDY	T2400010	1	PORTAFUSIBILE	FUSEHOLDER	PORTE-FUSIBLE	SICHERUNGSHALTER	PORTAFUSIBLE
44	INDY	T2911003	1	PIASTRINA	SUPPORT PLATE	PLAQUETTE	STÜTZPLATTE	OREJA DE APOYO
50				VITE Ø 4,2x16 TCTC AUTOFIL.	SCREW	VIS	SCHRAUBE	TORNILLO
51				VITE M3x16 TCTC UNI 7687	SCREW	VIS	SCHRAUBE	TORNILLO
52				DADO M3 AUTOBL. UNI 7474	LOCK NUT	ECROU AUTOBLOQUANT	STOPMUTTER	TUERCA AUTOBLOCANTE
53				DADO M3 OTTONE	NUT	ECROU	MUTTER	TUERCA
54				RONDELLA Ø 4x8 UNI 6592	WASHER	RONDELLE	UNTERLAGSCHEIBE	ARANDELA

TAV.13 rev.02 GRUPPO COMPONENTI ELETTRICI M65/70/75/83

Pos.	Mod.	Codice	Q.tà	Denominazione	Denomination	Description	Benennung	Descripcion
55				VITE M4x50 UNI 5739	SCREW	VIS	SCHRAUBE	TORNILLO
56				RONDELLA Ø 5x10 UNI 6592	WASHER	RONDELLE	UNTERLAGSCHEIBE	ARANDELA
57				DADO M4 UNI 5588	NUT	ECROU	MUTTER	TUERCA
58				DADO M4 AUTOBL. UNI 7474	LOCK NUT	ECROU AUTOBLOQUANT	STOPMUTTER	TUERCA AUTOBLOCANTE
59				VITE M4x6 UNI 7687	SCREW	VIS	SCHRAUBE	TORNILLO
60				RONDELLA Ø 4 GROWER	LOCK WASHER	RONDELLE FREIN	ZAHNSCHEIBE	ARANDELA DENTADA
61				DADO M10 UNI 5589 INOX	NUT	ECROU	MUTTER	TUERCA
62				RONDELLA Ø 10 OTTONE	WASHER	RONDELLE	UNTERLAGSCHEIBE	ARANDELA
63				RONDELLA Ø 10 GROWER	LOCK WASHER	RONDELLE FREIN	ZAHNSCHEIBE	ARANDELA DENTADA
64				VITE M4x20 TCTC UNI 7687	SCREW	VIS	SCHRAUBE	TORNILLO
65				VITE M10x40 TE UNI 5739 INOX	SCREW	VIS	SCHRAUBE	TORNILLO
66				VITE M6x20 TE UNI 5739 INOX	SCREW	VIS	SCHRAUBE	TORNILLO
67				RONDELLA Ø 6 GROWER	LOCK WASHER	RONDELLE FREIN	ZAHNSCHEIBE	ARANDELA DENTADA
68				RONDELLA Ø 6x12 UNI 6592	WASHER	RONDELLE	UNTERLAGSCHEIBE	ARANDELA
69				VITE M5x30 TE UNI 5739	SCREW	VIS	SCHRAUBE	TORNILLO
70				DADO M5 UNI 5587	NUT	ECROU	MUTTER	TUERCA
71				DADO M5 AUTOBL. UNI 7474	LOCK NUT	ECROU AUTOBLOQUANT	STOPMUTTER	TUERCA AUTOBLOCANTE
72				VITE M4x20 TE UNI 5739	SCREW	VIS	SCHRAUBE	TORNILLO
73				VITE M4x12 TPSTC UNI 7688	SCREW	VIS	SCHRAUBE	TORNILLO

* INDY/PROFY/KLINIK LINE

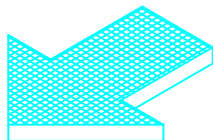
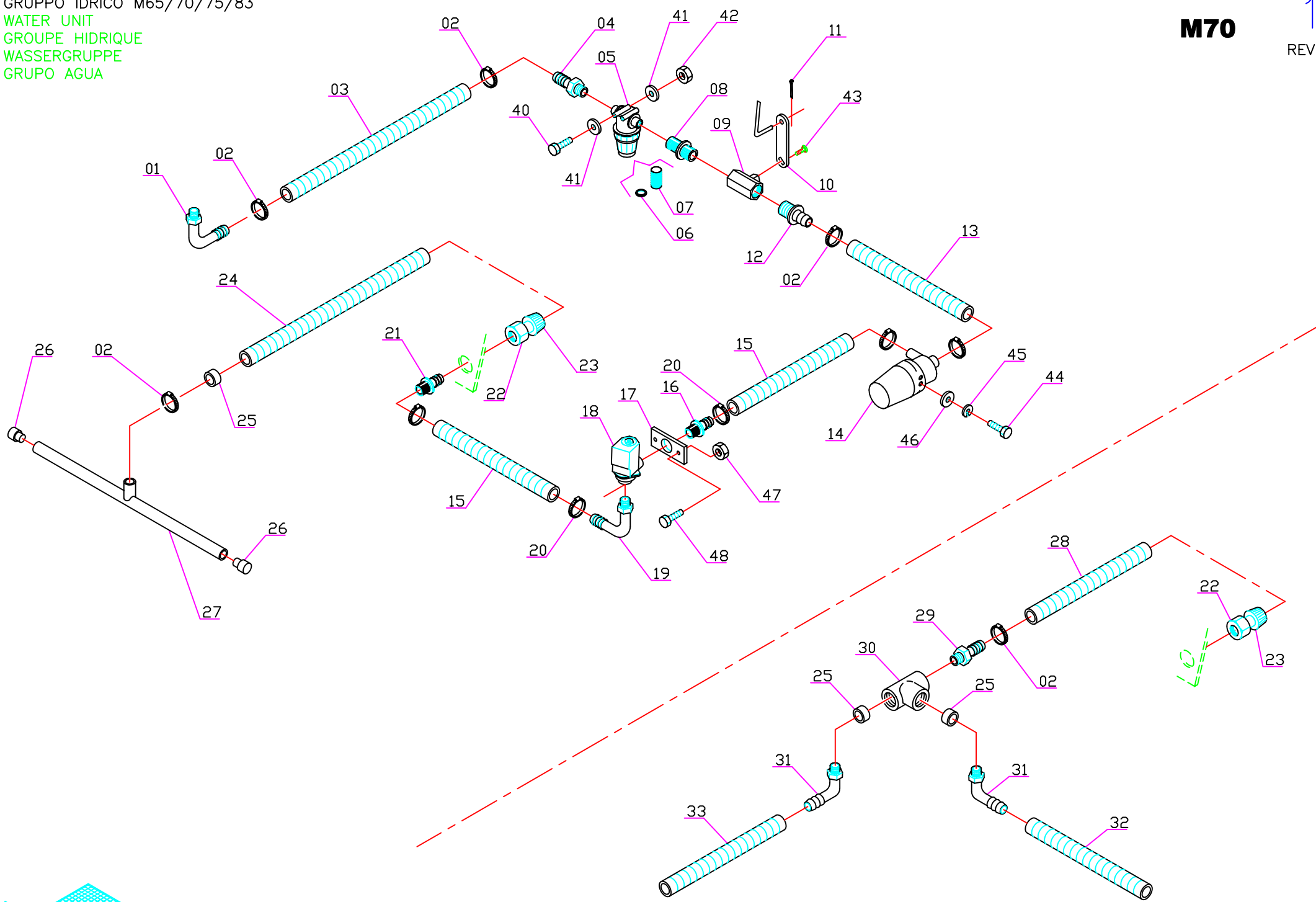

Pos.	Mod.	Codice	Q.tà	Denominazione	Denomination	Description	Benennung	Descripcion
01		T4520002	01	PORTAGOMMA A GOMITO	FITTING	RACCORD	VERSCHRAUBUNG	EMPALME TUBO DE GOMA
02		T4220006	07	FASCIETTA A VITE	CLAMP	COLLIER	BRIDE	ABRAZADERA
03		E7510070	01	TUBO SPIRALATO D14x450	PIPE	TUBE	ROHR	TUBO
04		T4540028	01	PORTAGOMMA DIRITTO	FITTING	RACCORD	VERSCHRAUBUNG	EMPALME TUBO DE GOMA
05		E6500290	01	FILTRO	FILTER	FILTRE	FILTER	FILTRO
06		E7400450	01	GUARNIZIONE FILTRO	GASKET	JOINT	ABDICHTUNG	JUNTA
07		E6500310	01	CARTUCCIA FILTRO	FILTER CARTRIDGE	CARTOUCHE DE FILTRE	FILTREINSATZ	CARTUCHO FILTRO
08		T4560020	01	RIDUZIONE NIPLO	NIPPLE	RACCORD	NIPPEL	BOQUILLA ROSCADA
09		T4510005	01	CORPO RUBINETTO	COCK	ROBINET	WASSERHAHN	GRIFO
10		R2837020	01	LEVA RUBINETTO	COCK LEVER	LEVIER DE ROBINET	WASSERHAHNHEBEL	PALANCA DE GRIFO
11		T1502002	01	COPIGLIA 2x20 INOX	SPLIT PIN	GOUPILLE	SPLINT	PASADOR DE ALETAS
12		T4540027	01	PORTAGOMMA DIRITTO	FITTING	RACCORD	VERSCHRAUBUNG	EMPALME TUBO DE GOMA
13		E7510660	01	TUBO SPIRALATO D14x750	PIPE	TUBE	ROHR	TUBO
14		E8701020	01	POMPA	MOTOR PUMP	MOTOPOMPE	MOTORPUMPE	MOTOBOMBA
15		E7510240	02	TUBO SPIRALATO D14x300	PIPE	TUBE	ROHR	TUBO
16		T4540006	01	PORTAGOMMA DIRITTO	FITTING	RACCORD	VERSCHRAUBUNG	EMPALME TUBO DE GOMA
17		R2437020	01	PIASTRINA	SUPPORT PLATE	PLAQUETTE	STÜTZPLATTE	OREJA DE APOYO
18		E8533030	01	ELETTROVALVOLA COMPLETA	SOLENOID VALVE	ELECTROVANNE	MAGNETVENTIL	ELECTROVALVULA
19		T4520010	01	PORTAGOMMA A GOMITO	FITTING	RACCORD	VERSCHRAUBUNG	EMPALME TUBO DE GOMA
20		T4220005	02	FASCIETTA A VITE	CLAMP	COLLIER	BRIDE	ABRAZADERA
21		T4540003	01	PORTAGOMMA DIRITTO	FITTING	RACCORD	VERSCHRAUBUNG	EMPALME TUBO DE GOMA
22		T4540001	01	INNESTO RAPIDO MASCHIO	MALE COUPLING	EMBAYAGE MALE	KUPPLUNG MIT ZAPFEN	ACOPLAMIENTO
23		T4540002	01	RACCORDO RAPIDO	FEMALE COUPLING	EMBAYAGE FEMELLE	KUPPLUNG OHNE ZAPFEN	ACOPLAMIENTO
24	M70	E7510560	01	TUBO SPIRALATO D14x650	PIPE	TUBE	ROHR	TUBO
25		E9000280	01	DISTANZIALE	SPACER	ENTRETOISE	DISTANZHÜLSE	DISTANCIADOR
26	M70	T4803015	02	CAPPUCCIO COPRIDADO	CAP	CAPUCHON	KAPPE	TAPON
27	M70	R2901220	01	TUBO DISTRIBUTORE	PIPE	TUBE	ROHR	TUBO
28		E7510510	01	TUBO SPIRALATO D14x550	PIPE	TUBE	ROHR	TUBO
29		T4520007	01	PORTAGOMMA DIRITTO	FITTING	RACCORD	VERSCHRAUBUNG	EMPALME TUBO DE GOMA
30		T4530002	01	RACCORDO A T	FITTING	RACCORD	VERSCHRAUBUNG	RACORT
31		T4520011	02	PORTAGOMMA A GOMITO	FITTING	RACCORD	VERSCHRAUBUNG	EMPALME TUBO DE GOMA
32		E7521090	01	TUBO SPIRALATO D14x350	PIPE	TUBE	ROHR	TUBO
33		E7521300	01	TUBO SPIRALATO D14x230	PIPE	TUBE	ROHR	TUBO
40		-	-	VITE TE M8x80 UNI5737	SCREW	VIS	SCHRAUBE	TORNILLO
41		-	-	ROSETTA M8 UNI 6592	WASHER	RONDELLE	SCHIBE	ARANDELA
42		-	-	DADO AUTOBL. M8 UNI7474	LOCK NUT	ECROU AUTOBLOQUANT	STOPMUTTER	TUERCA AUTOBLOCANTE
43		-	-	VITE TCTC M3x10 UNI7687	SCREW	VIS	SCHRAUBE	TORNILLO
44		-	-	VITE TE M6x16 UNI5739	SCREW	VIS	SCHRAUBE	TORNILLO
45		-	-	ROSETTA M6 UNI1751	LOCK WASHER	RONDELLE	ZAHNSCHIBE	ARANDELA DENTADA
46		-	-	ROSETTA M6 UNI6592	WASHER	RONDELLE	SCHIBE	ARANDELA
47		-	-	DADO M4 AUTOBL. UNI7474	LOCK NUT	ECROU AUTOBLOQUANT	STOPMUTTER	TUERCA AUTOBLOCANTE
48		-	-	VITE TCTC M4x12 UNI7687	SCREW	VIS	SCHRAUBE	TORNILLO

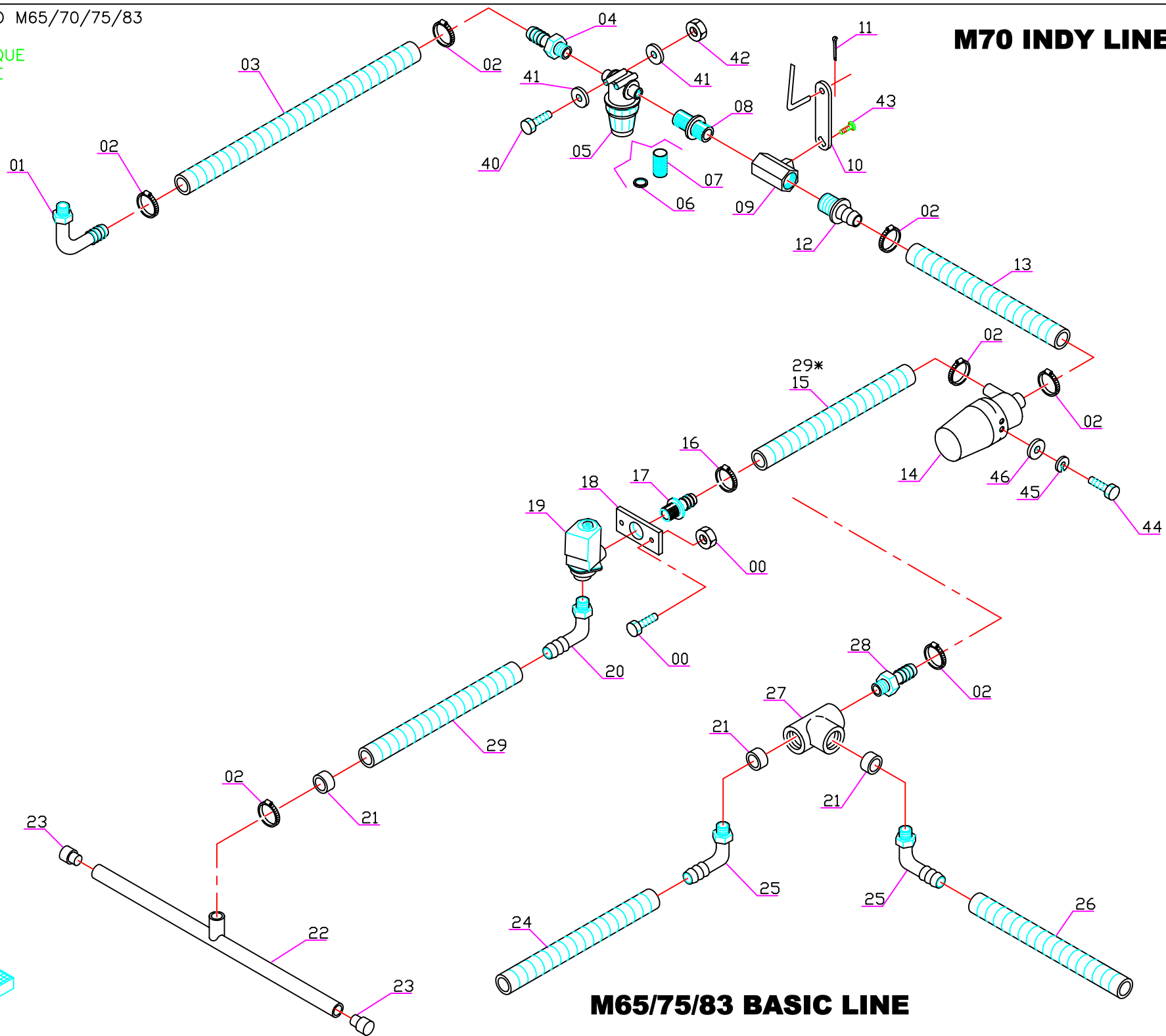

M65/75/83 BASIC LINE

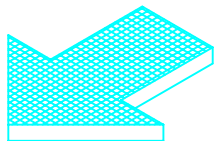

Pos.	Mod.	Codice	Q.tà	Denominazione	Denomination	Description	Benennung	Descripcion
01		T4520002	01	PORTAGOMMA A GOMITO	FITTING	RACCORD	VERSCHRAUBUNG	EMPALME TUBO DE GOMA
02		T4220006	07	FASCIETTA A VITE	CLAMP	COLLIER	BRIDE	ABRAZADERA
03		E7510070	01	TUBO SPIRALATO D14x450	PIPE	TUBE	ROHR	TUBO
04		T4540028	01	PORTAGOMMA DIRITTO	FITTING	RACCORD	VERSCHRAUBUNG	EMPALME TUBO DE GOMA
05		E6500290	01	FILTRO	FILTER	FILTRE	FILTER	FILTRO
06		E7400450	01	GUARNIZIONE FILTRO	GASKET	JOINT	ABDICHTUNG	JUNTA
07		E6500310	01	CARTUCCIA FILTRO	FILTER CARTRIDGE	CARTOUCHE DE FILTRE	FILTREINSATZ	CARTUCHO FILTRO
08		T4560020	01	RIDUZIONE NIPLO	NIPPLE	RACCORD	NIPPEL	BOQUILLA ROSCADA
09		T4510005	01	CORPO RUBINETTO	COCK	ROBINET	WASSERHAHN	GRIFO
10		R2837020	01	LEVA RUBINETTO	COCK LEVER	LEVIER DE ROBINET	WASSERHAHNHEBEL	PALANCA DE GRIFO
11		T1502002	01	COPIGLIA 2x20 INOX	SPLIT PIN	GOUPILLE	SPLINT	PASADOR DE ALETAS
12		T4540027	01	PORTAGOMMA DIRITTO	FITTING	RACCORD	VERSCHRAUBUNG	EMPALME TUBO DE GOMA
13		E7510660	01	TUBO SPIRALATO D14x750	PIPE	TUBE	ROHR	TUBO
14		E8701020	01	POMPA	MOTOR PUMP	MOTOPOMPE	MOTORPUMPE	MOTOBOMBA
15	M70	E7510240	02	TUBO SPIRALATO D14x300	PIPE	TUBE	ROHR	TUBO
16		T4220005	02	FASCIETTA A VITE	CLAMP	COLLIER	BRIDE	ABRAZADERA
17		T4540006	01	PORTAGOMMA DIRITTO	FITTING	RACCORD	VERSCHRAUBUNG	EMPALME TUBO DE GOMA
18		R2437020	01	PIASTRINA	SUPPORT PLATE	PLAQUETTE	STÜTZPLATTE	OREJA DE APOYO
19		E8533030	01	ELETTRIVALVOLA COMPLETA	SOLENOID VALVE	ELECTROVANNE	MAGNETVENTIL	ELECTROVALVULA
20		T4520010	01	PORTAGOMMA A GOMITO	FITTING	RACCORD	VERSCHRAUBUNG	EMPALME TUBO DE GOMA
21		E9000280	01	DISTANZIALE	SPACER	ENTRETOISE	DISTANZHÜLSE	DISTANCIADOR
22	M70	R2901220	01	TUBO DISTRIBUTORE	PIPE	TUBE	ROHR	TUBO
23	M70	T4803015	02	CAPPUCCIO COPRIDADO	CAP	CAPUCHON	KAPPE	TAPON
24		E7521300	01	TUBO SPIRALATO D14x230	PIPE	TUBE	ROHR	TUBO
25		T4520011	02	PORTAGOMMA A GOMITO	FITTING	RACCORD	VERSCHRAUBUNG	EMPALME TUBO DE GOMA
26		E7521090	01	TUBO SPIRALATO D14x350	PIPE	TUBE	ROHR	TUBO
27		T4530002	01	RACCORDO A T	FITTING	RACCORD	VERSCHRAUBUNG	RACORT
28		T4520007	01	PORTAGOMMA DIRITTO	FITTING	RACCORD	VERSCHRAUBUNG	EMPALME TUBO DE GOMA
29	M70	E7510890	01	TUBO SPIRALATO D14x1250	PIPE	TUBE	ROHR	TUBO
29*		E7510890	01	TUBO SPIRALATO D14x1250	PIPE	TUBE	ROHR	TUBO
40		-	-	VITE TE M8x80 UNI5737	SCREW	VIS	SCHRAUBE	TORNILLO
41		-	-	ROSETTA M8 UNI 6592	WASHER	RONDELLE	SCHEIBE	ARANDELA
42		-	-	DADO AUTOBL. M8 UNI7474	LOCK NUT	ECROU AUTOBLOQUANT	STOPMUTTER	TUERCA AUTOBLOCANTE
43		-	-	VITE TCTC M3x10 UNI7687	SCREW	VIS	SCHRAUBE	TORNILLO
44		-	-	VITE TE M6x16 UNI5739	SCREW	VIS	SCHRAUBE	TORNILLO
45		-	-	ROSETTA M6 UNI1751	LOCK WASHER	RONDELLE	ZAHNSCHEIBE	ARANDELA DENTADA
46		-	-	ROSETTA M6 UNI6592	WASHER	RONDELLE	SCHEIBE	ARANDELA

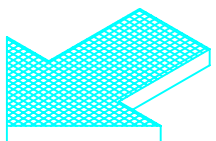
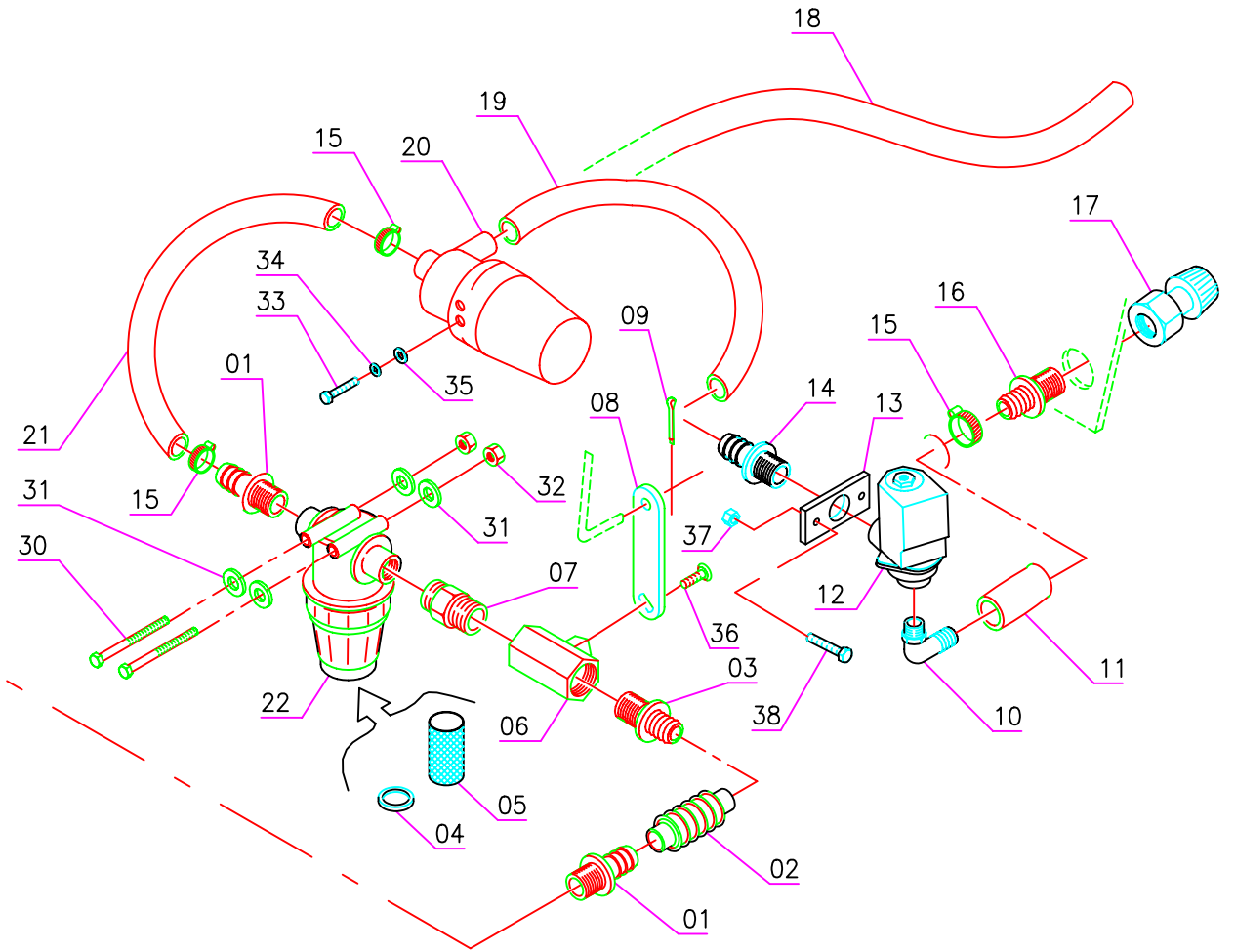
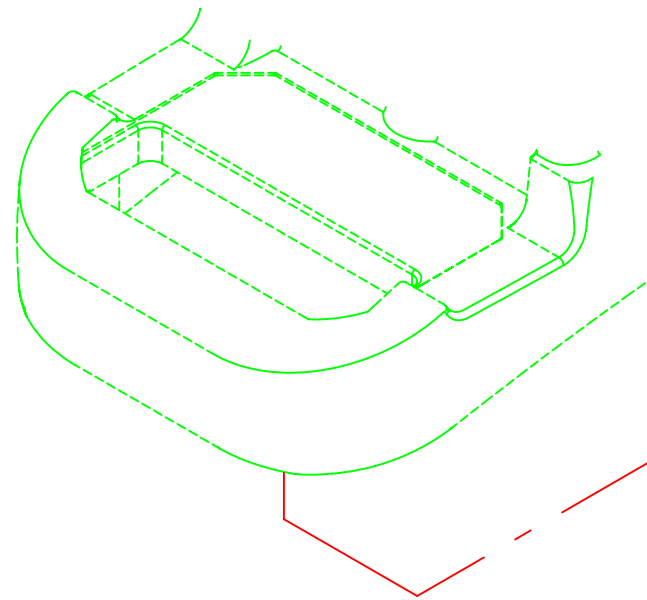

Pos.	Mod.	Codice	Q.tà	Denominazione	Denomination	Description	Benennung	Descripcion
01		T4520007	2	PORTAGOMMA DIRITTO 1/2x16	CONNECTOR	RACCORD	SCHLAUCHANSCHLUSS	EMPALME TUBO DE GOMA
02		T4806043	1	SOFFIETTO	BELLOWS	SOUFFLET	FALTENBALG	FUELLE
03		T4540027	1	PORTAGOMMA 1/4x14	CONNECTOR	RACCORD	SCHLAUCHANSCHLUSS	EMPALME TUBO DE GOMA
04		E7400450	1	GUARNIZIONE FILTRO	GASKET	GARNITURE	DICHTUNG	GURNICION
05		E6500310	1	CARTUCCIA FILTRO SOMESCH	FILTER CARTRIDGE	CARTOUCHE DE FILTRE	FILTEREINSATZ	CARTUCHO FILTRO
06		T4510005	1	RUBINETTO 1/4 F.F.	COCK	ROBINET	WASSERHAHN	GRIFO
07		T4560020	1	NIPPLO RIDUZIONE 1/4-1/2	NIPPLE	RACCORD	NIPPEL	BOQUILLA ROSCADA
08		R2837020	1	LEVA RUBINETTO	COCK LEVER	LEVIER DE ROBINET	WASSERHAHNHEBEL	PALANCA GRIFO
10		T4520010	1	PORTAGOMMA GOMITO 3/8x13	CONNECTOR	RACCORD	SCHLAUCHANSCHLUSS	EMPALME TUBO DE GOMA
11		E7510240	2	TUBO Ø 14x300	HOSE	TUYAU	SCHLAUCH	TUBO DE GOMA
12		E8533030	1	ELETTROVALVOLA COMPLETA	SOLENOID VALVE	ELECTROVANNE ASSY	MAGNETVENTIL COMPLETE	ELECTROVALVULA COMPLETA
13		R2437020	1	PIASTRINA	PLAQUE	PLAQUETTE	BEFESTIGUNGSAUFLAGE	PLAQUETA
14		T4540006	1	PORTAGOMMA DIRITTO 3/8x13	CONNECTOR	RACCORD	SCHLAUCHANSCHLUSS	EMPALME TUBO DE GOMA
16		T4540003	1	PORTAGOMMA DIRITTO 3/4x16	CONNECTOR	RACCORD	SCHLAUCHANSCHLUSS	EMPALME TUBO DE GOMA
17		T4540001	1	INNESTO RAPIDO	QUICK COUPLING	EMBRAYAGE RAPIDE	SCHNELLE KUPPLUNG	ENCHUFE
18	*	E7510890	1	TUBO Ø 14x1250	HOSE	TUYAU	SCHLAUCH	TUBO DE GOMA
20		E8701020	1	POMPA 36V	MOTOR PUMP	MOTOPOMPE	MOTORPUMPE	MOTOBOMBA
21		E7510440	1	TUBO Ø 14x250	HOSE	TUYAU	SCHLAUCH	TUBO DE GOMA
22		E6500290	1	FILTRO COMPLETO SOMESCH	FILTER	FILTRE	FILTER	FILTRO
30		-	-	VITE M8x80 TE UNI 5737	SCREW	VIS	SCHRAUBE	TORNILLO
31		-	-	RONDELLA Ø 8x17 UNI 6592	WASHER	RONDELLE	UNTERLAGSCHEIBE	ARANDELA
32		-	-	DADO M8 AUTOBL. UNI 7474	LOCK NUT	ECROU AUTOBLOQUANT	STOPMUTTER	TUERCA AUTOBLOCANTE
33		-	-	VITE M6x16 TE UNI 5739	SCREW	VIS	SCHRAUBE	TORNILLO
34		-	-	RONDELLA Ø 6 GROWER	LOCK WASHER	RONDELLE FREIN	ZAHNSCHEIBE	ARANDELA DENTADA
35		-	-	RONDELLA Ø 6x12 UNI 6592	WASHER	RONDELLE	UNTERLAGSCHEIBE	ARANDELA
36		-	-	VITE M3x10 TCTC UNI 7985	SCREW	VIS	SCHRAUBE	TORNILLO
37		-	-	DADO M4 AUTOBL. UNI 7474	LOCK NUT	ECROU AUTOBLOQUANT	STOPMUTTER	TUERCA AUTOBLOCANTE
38		-	-	VITE M4x12 UNI 7985	SCREW	VIS	SCHRAUBE	TORNILLO

* = BASIC ; INDY LINE



pulito personalizzato
customized cleaning

NOTE

A series of horizontal dashed lines for writing notes.